

The logo of the Australian Sports Rotorcraft Association (ASRA) is faintly visible in the background. It features a stylized rotorcraft silhouette with a propeller and a tail boom, set against a circular emblem. The emblem contains the text 'AUSTRALIAN SPORTS ROTORCRAFT ASSOCIATION' and 'ASRA INCORPORATED'.

ASRA COMPLIANT GYROPLANE CONSTRUCTION STANDARDS

Table of Contents

Table of Contents	2
INTRODUCTION	6
NEW GYROPLANE REGISTRATION PROCEDURE	7
ABBREVIATIONS AND DEFINITIONS	8
SUBPART A- General	9
A5 Purpose.....	9
A10 Applicability.....	9
SUBPART B – Flight	10
GENERAL	10
B5 Proof of Compliance	10
B10 Load Distribution Limits	10
B15 Maximum weight of compliant gyroplanes	10
B16 Observations about realistic occupant weights	10
B17 Single-occupant unfuelled weight.....	11
B18 Dual-occupant unfuelled weight	11
B19 Maximum take-off weight (MTOW) and calculation of fuel capacity	11
B20 Empty Weight.	12
B25 Removable Ballast	12
B30 Tilt Back Test.....	12
B32 Rotor Speed Limits.....	12
PERFORMANCE	12
B35 General.....	12
B40 Take-off Distance	12
B45 Climb Rate.....	13
B50 Minimum Sink Rate	13
B52 Best Glide Ratio.....	13
B55 Never Exceed Airspeed (VNE).....	13
B60 Minimum Controllable Speed for Level Flight (VMIN)	13
B65 Best Rate of Climb Airspeed (VY)	13
B70 Landing Distance.....	13
B75 Maximum Operating Altitude	13
B80 Height/Velocity Envelope	13
CONTROLLABILITY AND MANOEUVRABILITY	14
B85 General.....	14
B90 Longitudinal Lateral and Directional Control	15
B95 Pitch Control Force in Manoeuvres	15
STABILITY	15
B100 General.....	15
B105 Longitudinal Stability	15
B110 Lateral and Directional Stability	16
B115 Dynamic Longitudinal Stability	16
GROUND HANDLING CHARACTERISTICS	17
B120 Directional Stability and Control	17
B125 Taxiing Condition.....	17
B127 Ground Resonance	17
MISCELLANEOUS FLIGHT REQUIREMENTS	17
B130 Vibration	17
SUBPART C – Structure	18
General	18
C5 Loads	18
C10 Factor of Safety	18
C15 Strength and Deformation	18
C20 Design Conditions	18
FLIGHT LOADS	18
C25 General.....	18
C30 Limit Manoeuvring Load Factors	18
C35 Resulting Limit Manoeuvring Loads	18
C40 Yawing Conditions.....	18
C45 Engine Torque.....	19

C50	Side Load of Engine Mount	19
CONTROL SURFACES AND SYSTEM LOADS		19
C55	Primary Control System	19
C56	Control System Design	19
C60	Limit Pilot Forces	20
C70	Secondary Control Systems	20
STABILISING AND CONTROL SURFACES		20
C75	Control Surface Loads	20
GROUND LOADS		20
C80	General	20
C85	Landing Gear - Shock Absorption	20
MAIN COMPONENT REQUIREMENTS		21
C90	Rotor Structure	21
C95	Fuselage, Landing Gear and Rotor Pylon Structures	21
EMERGENCY LANDING CONDITIONS		21
C100	General	21
OTHER- LOADS		22
C105	Loads from Single Masses	22
SUBPART D - Design and Construction		23
D5	General	23
D10	Materials	23
D15	Fabrication Methods	23
D20	Locking of Connections	23
D25	Protection of Structure	23
D30	Inspection	23
D35	Provisions for Rigging and De-rigging	23
D40	Material Strength, Properties and Design Values	23
D45	Fatigue Strength	24
D50	Special Factors of Safety	24
D55	Casting Factors	24
D60	Bearing Factors	24
D65	Fitting Factors	24
D70	Cable Factor	25
D75	Flutter Prevention and Structural Stiffness	25
CONTROL SURFACES AND ROTORS		25
D80	Drainage	25
D85	Control Surface Installations (other than rotor blades)	25
D90	Control Surface Hinges (other than rotor blades)	25
D95	Mass Balance	25
D100	Rotor Hub Tilt and Teeter Ranges	26
D101	Reserved	27
D102	Rotor Clearances	27
D103	Examination of First of Type Gyroplanes	28
D105	Rotor Head Bearings	28
D107	Rotor Disc Loading	28
CONTROL SYSTEMS		28
D110	General	28
D115	Stops	28
D120	Rotor System Stops	28
D125	Trim System	28
D130	Operation of Controls	29
D135	Control System Details	29
D140	Spring Devices	29
D145	Cable Systems	29
D150	Joints	30
COCKPIT DESIGN		30
D155	General	30
D160	Cockpit View	30
D165	Windshields Windows and Doors	30
D170	Cockpit Controls	31

D175	Flight Controls	31
D180	Seats	31
D185	Safety Harnesses	31
D190	Protection from Injury	31
D195	Baggage Compartment	31
D200	Emergency Exit	31
D205	Ventilation.....	32
SUBPART E - Powerplant.....		33
GENERAL		33
E5	Installation.....	33
E10	Compatibility.....	33
E15	Rotor Spin-up and Brake Systems.....	33
E20	Flight Endurance Test	33
E25	Propeller Clearance.....	34
E27	Propeller Materials and Durability	34
FUEL SYSTEM.....		34
E30	General.....	34
E35	Fuel Flow.....	34
E40	Fuel Quantity	34
E45	Integrity of Fuel Tanks.....	35
E50	Fuel Tank Test.....	35
E55	Fuel Tank Installation	35
E60	Fuel Tank Sump	35
E65	Fuel Tank Filler Connection	35
E70	Fuel Tank Vents	35
E75	Fuel Strainer or Filter.....	36
E80	Fuel System Lines and Fittings	36
E85	Fuel Valves and Controls	36
OIL SYSTEM		36
E90	General.....	36
E95	Oil Tanks	36
E100	Oil Tank Test	36
E105	Oil Lines and Fittings.....	37
COOLING		37
E110	General.....	37
INDUCTION SYSTEM		37
E115	Air Induction.....	37
EXHAUST SYSTEM.....		37
E120	General.....	37
E125	Exhaust Manifold, Piping and Silencing	37
POWERPLANT CONTROLS AND ACCESSORIES.....		38
E130	General.....	38
E135	Engine Ignition System.....	38
E140	Propeller Speed.....	38
E145	Cowling and Nacelle.....	38
SUBPART F - Equipment.....		39
GENERAL		39
F5	Function and Installation.....	39
F10	Flight and Navigation Instruments.....	39
F15	Powerplant Instruments.....	39
F20	Miscellaneous Equipment	39
INSTRUMENTS – INSTALLATION		39
F25	Arrangement and Visibility.....	39
F30	Pitot and Static Pressure Systems	39
F35	Powerplant Instruments.....	39
ELECTRICAL SYSTEMS AND EQUIPMENT		40
F40	Battery Design and Installation.....	40
F45	Electric Cables and Equipment	40
F50	External Lights.....	40
MISCELLANEOUS EQUIPMENT		40

F55 Airborne Radio and Radio Navigation Equipment..... 40

SUBPART G - Operating Limitations and Information 41

G5 GENERAL 41

G10 Air-speed Limitations 41

G15 Weight and Balance. 41

G20 Powerplant and Propeller Limitations..... 41

FLIGHT MANUAL 41

G25 Flight Manual or Pilot Operating Handbook 41

MARKINGS AND PLACARDS 42

G30 General 42

G35 Operating Limitations, Placards and Instrument Markings 42

G40 Compass 42

G45 Fuel Quantity Indicator 42

G50 Control Markings 42

G55 Miscellaneous Markings and Placards 43

INSTALLATION OF SHOULDER HARNESS 44

NOMOGRAPH OF EFFECTS OF TEMPERATURE AND ALTITUDE ON CLIMB RATES 45

APPENDIX 1 46

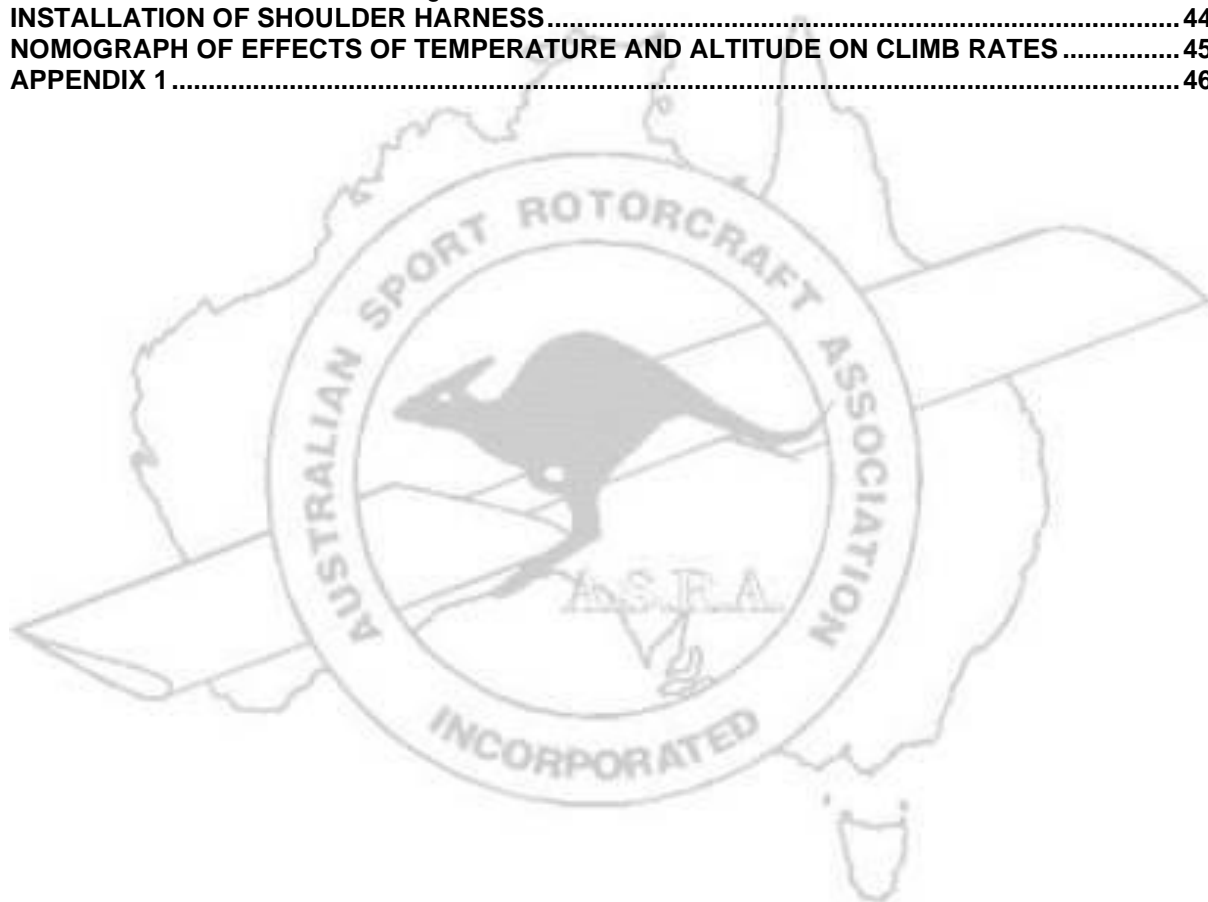

INTRODUCTION

Neither CASA nor ASRA guarantee the airworthiness of any gyroplane, and pilots fly gyroplanes at entirely their own risk.

The Construction Standards must therefore be seen as solely a pre-requisite for registration and not to be considered as any information to which any form of liability attaches.



NEW GYROPLANE REGISTRATION PROCEDURE.

The flow chart below represents the steps to follow to obtain final Compliant registration.

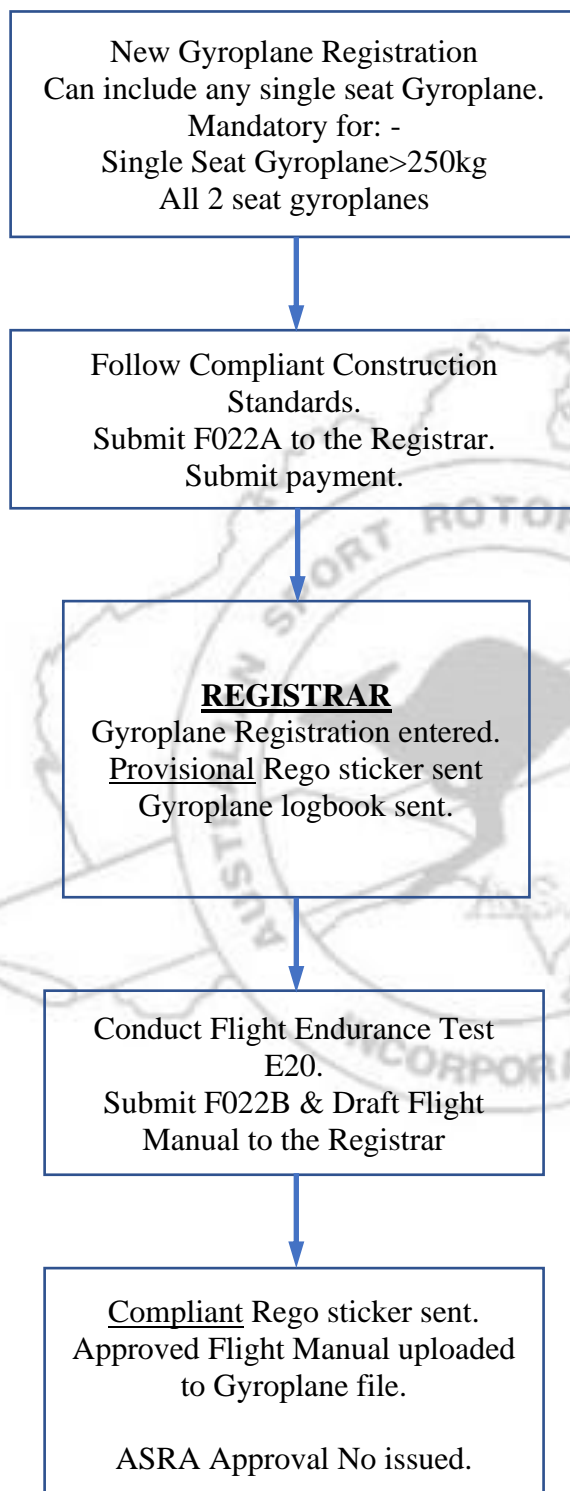

ABBREVIATIONS AND DEFINITIONS

Factor of safety	Multiplier of limit load to determine design ultimate load.
Fire proof	Capable of withstanding for a period of at least 15 minutes the application of heat by the standard flame.
Fire resistant	Capable of withstanding for a period of at least 5 minutes of heat by standard flame.
Standard flame	A flame with the characteristics which are similar to those described in BS3G.100 part 2 Section 3013.
Limit load	Maximum expected static load on a component.
Primary structure	Those parts of the structure the failure of which would endanger the gyroplane.
Power off	For testing purposes means engine at idle.
Cockpit	The position from which the pilot controls the gyroplane, whether it is enclosed or not.
Ultimate load	Limit load multiplied by the factor of safety.

Acronyms

C of G	Centre of gravity
EAS	Equivalent air speed.
IAS	Indicated air speed.
PSIG	Pounds per Square Inch Gauge
RPM	Revolutions Per Minute
VD	The Maximum Design Speed, EAS.
VDF	The Maximum Demonstrated Flight Speed. EAS.
VNE	The Never Exceed Speed, IAS.
VY	Best Rate of Climb Speed, IAS.
VMIN	Minimum Level Flight Speed, IAS.
VH	Maximum speed in level flight with the engine at maximum continuous power, IAS.
g	The acceleration due to gravity is 9.80 ms^{-2}

SUBPART A- General

A5 Purpose

These Construction Requirements (hereinafter referred to as the "Requirements") have been submitted to the Civil Aviation Safety Authority (CASA) to enable the Australian Sport Rotorcraft Association (ACT) Inc. (ASRA) to register a gyroplane for operation as a Compliant Gyroplane under the authority granted by CAO 95.12 and CAO95.12.1 and, when gazetted, CASR parts 103 and 149.

A10 Applicability

- (a) These requirements shall be applicable to gyroplanes conforming to the requirements of CAO 95.12 and CAO 95.12.1 namely: -
- (i) CAO 95.12 one occupant, and
 - (ii) An empty weight not exceeding 250 kg., or
 - (iii) CAO95 .12.1 Not more than two occupants; and
 - (iv) A maximum take-off weight not exceeding 600 kg.

When CASR part 103 is gazetted CAO 95.12 and CAO 95.12.1 will be discontinued and these requirements shall be applicable to gyroplanes conforming to the requirements of CASR part 103.005 item (4) namely: -

- (i) it has 1 or 2 seats; and
 - (ii) it has only 1 engine and only 1 propeller; and
 - (iii) its rotor disc loading is no more than 20 kilogram per square meter; and
 - (iv) its MTOW is no more than 600 kilograms; or
 - (v) if it is equipped to land on water 650 kilogram.
- (b) A gyroplane is defined as a rotorcraft with rotor blades that are not engine driven in flight, and is supported in flight by the reaction of the air on one of more rotors which rotate freely on substantially vertical axes, when the aircraft is in horizontal flight.
- (c) These requirements apply to gyroplanes of orthodox design. Aircraft having the following basic features will be so regarded: -
- (i) A single non-power-driven teetering rotor of either fixed pitch or pitch control that is not adjustable in flight;
 - (ii) A conventional 'offset gimbal' rotor head, through which varying flight loads are transmitted to the control column;
 - (iii) Where the horizontal stabiliser incorporates control surfaces, these are not to be adjustable in flight.
- (d) Where it can be shown that a particular feature is similar in all significant respects to a feature which has historically demonstrated compliance with these requirements, and can be considered a separate entity in terms of its operation, that feature shall be deemed to be applicable and in compliance with these requirements.
- (e) Where these requirements are inappropriate to particular design and construction features it will be necessary to reconsider the validity of the requirements for each particular case. The ASRA's Technical Manager must be consulted to determine the applicable requirements.
- (f) Permitted Operations.
- These requirements apply to gyroplanes designed for non-aerobatic operation, including: -
- (i) Any manoeuvre necessary for normal flying.
 - (ii) Steep turns in which the angle of bank does not exceed 60 degrees.
 - (iii) Vertical descents.

SUBPART B – Flight

GENERAL

B5 Proof of Compliance

- (a) Each requirement of this subpart must be met by test upon the Gyroplane at the most adverse combination of weight and balance within the range of loading conditions within which the gyroplane will be operated.
- (b) Unless otherwise stipulated, performance requirements are at standard atmospheric conditions.
- (c) Each requirement of this section must be met for all configurations at which the gyroplane will be operated except as otherwise stated. (If, for example, a gyroplane is equipped with a canopy or doors and it is intended that the gyroplane may be operated with the canopy or doors removed, then the gyroplane must meet the requirements both with and without the canopy or doors installed.).

B10 Load Distribution Limits

- (a) The range of weight and balance within which the gyroplane is to be safely operated must be selected by the designer.
- (b) The selected range must be within the range of that corresponds to the minimum selected weight for a pilot alone (plus ballast if required) up to the maximum selected weight. The maximum selected weight must include pilot (and passenger), all fuel and payload that it is intended to be carried. The weight of pilot (and passenger) must be considered to be not less than 90 kg per person.
- (c) The selected range of weight and balance must be specified in the Flight Manual.
- (d) Except where the designer specifies otherwise, the recommended balance or hang test range is between 9 and 12 degrees nose down, measured on the horizontal datum line, when the gyroplane is suspended from the teeter bolt, with the control column in the neutral position, with both maximum and minimum usable fuel (As defined in E40.) and with the pilot in the pilot's seat, or in the case of a two seat gyroplane, with a single pilot and with a pilot and passenger. Also refer to appendix 1

B15 Maximum weight of compliant gyroplanes

Maximum weight for 2-place gyroplanes or single place gyroplanes in the compliant category or single place gyroplanes certificated as light sport aircraft is **600 kilograms**. The maximum weight must be recorded in the Flight Manual.

B16 Observations about realistic occupant weights

CASA Advisory Publication 235-1(1) September 1990 recommends that standard passenger weights not be used for the calculations for aircraft with 7 seats or less. The advisory did suggest, however, that average passenger weights for aircraft seating between 7 to 9 passengers at 86 kilograms for adult males and 71 kilograms for adult females. AP 235-1(1) stresses, however, the need for actual weights to be used.

CASA AP 235-1(1) is now more than 2 decades old. A more recent study by Transport Canada (2005) revealed that in Western society people are now noticeably heavier than in 1990. Transport Canada now publish average adult male weights as being 90.7 kilograms (summer) and 93.4 kilograms (winter) and average female weights as being 74.8 kilograms (summer) and 77.5 kilograms (winter).

ASRA further notes that the "demographic" of membership appears to be adult males of at least middle age, many with "middle age spread," therefore, it is likely that even the Canadian weights might be too low.

ASRA requires that gyroplane builders use "realistic" occupant weights - ideally the actual weights of the intended occupants.

For the purpose of lofting calculations where the actual weight of a 2nd occupant is not known, ASRA requires that the figure of **90 kilograms** be used.

B17 Single-occupant unfuelled weight

The single-occupant unfuelled weight comprises: -

- (a) the empty weight of the gyroplane in kilograms; plus
- (b) the actual weight in kilograms of the kitted-out pilot including protective clothing, helmet and gloves (if carried); plus
- (c) the actual combined weight in kilograms of portable communications and navigation devices (such as hand-held UHF and VHF radios, hand-held GPS devices, mobile phones, tablet or notebook computers, cameras, etc); plus
- (d) the actual combined weight in kilograms of tie down equipment, camping equipment, foodstuffs and any other goods carried, spare oil, necessary tools, EPIRB devices, life preservers (if carried) and survival provisions (if carried).

B18 Dual-occupant unfuelled weight

In the case of a 2-place gyroplane, the dual-occupant unfuelled weight comprises: -

- (a) the empty weight of the gyroplane in kilograms; plus
- (b) the actual weight of the kitted-out pilot including protective clothing, helmet and gloves (if carried) in kilograms; plus
- (c) the actual weight of the kitted-out 2nd occupant in kilograms including protective clothing, helmet and gloves (if carried) or if the identity of the kitted-out 2nd occupant is not known then for the purpose of initial fuel calculations the figure of 90 kilograms is to be used until the actual weight of any kitted-out 2nd occupant is measured; plus
- (d) the actual combined weight in kilograms of portable communications and navigation devices (such as hand-held UHF and VHF radios, hand-held GPS devices, mobile phones, tablet or notebook computers, cameras, etc); plus
- (e) the actual combined weight in kilograms of tie down equipment, camping equipment, foodstuffs and any other goods carried, spare oil, necessary tools, EPIRB devices, life preservers (if carried) and survival provisions (if carried).

B19 Maximum take-off weight (MTOW) and calculation of fuel capacity**WARNING**

*Members are warned, however, that a clear danger exists that the **600 kilograms** maximum take-off weight could easily be exceeded for gyroplanes carrying 2 occupants unless great care is taken to properly and carefully calculate the respective actual occupant and fuel weights before take-off.*

The maximum take-off weight (MTOW) for any particular flight is to be calculated as follows: -

- (a) For single-occupant operations - the total of all weights determined at B17; or
- (b) For dual-occupant operations - the total of all weights determined at B18; plus, a fuel load calculated at **0.73 kilograms per litre of gasoline** of sufficient quantity necessary for the intended flight and which, if necessary, takes up the available weight margin up to - but does not exceed the maximum allowable take-off weight of 600 kilograms.

For the avoidance of any doubt this maximum take-off weight calculation method is intended to allow 2-place and single place compliant gyroplanes to be fitted with sufficient fuel tank volume or supplementary tankage to allow for single-occupant long range cross-country and ferry flights.

B20 Empty Weight.

- (a) The empty weight must be determined by weighing the gyroplane with.
- (i) Fixed ballast;
 - (ii) Required minimum equipment; and
 - (iii) Unusable fuel, maximum oil and, where appropriate, engine coolant and hydraulic fluid and excluding: -
 1. Weight of occupant(s); and
 2. Other readily removable items of load.
- (b) The actual empty weight and the condition of the gyroplane at the time of determining empty weight must be detailed in the Flight Manual and be one that is well defined and easily repeated.

B25 Removable Ballast

Removable ballast may be used in compliance with the flight requirements of this section.

NOTE: Removable ballast must be secured in such a manner that it will remain in place when subjected to the loads specified in C105.

B30 Tilt Back Test

To precisely find out the relationship between vertical centre of gravity and propeller thrust-line for each individual gyroplane, with the result that individual owners (and ASRA) will become aware that the particular gyroplane is, or gyroplanes are, either LTL, CLT, or HTL. Refer to appendix 1 for proper procedure.

B32 Rotor Speed Limits

At the critical combinations of weight, altitude and airspeed the rotor speed must be stable and remain within the established safe range that would permit any expected manoeuvre to be performed safely. The "established safe range" must be determined by: -

- (a) the rotor blade manufacturer or,
- (b) an acceptable history of safe operation.

Compliance may also be established by use of acceptable aircraft manufacturing practices and by correct use of materials of known design strength and fatigue properties.

The rotor speed limits must be recorded in the Flight Manual.

PERFORMANCE**B35 General**

The performance prescribed in Subpart B must be determined: -

- (a) With normal piloting skill under average conditions;
- (b) In still air at sea-level corrected for ICAO defined standard atmosphere;
- (c) At the most critical weight; and centre of gravity combination;
- (d) Using engine power not in excess of the maximum declared for the engine type, and without exceeding power-plant and propeller limitations established under G20.

B40 Take-off Distance

The distance(s) required from rest, to take-off and climb to 50 ft above the take-off surface, with zero wind, must be determined using normally accepted flight technique(s) (with and without pre-rotator if it is determined that the Gyroplane is to be operated both ways).

These established take-off distances must be recorded in the Flight Manual.

B45 Climb Rate

The time for climb from leaving the ground up to 1000 ft above the field must be determined and when corrected to the international standard day conditions at sea-level, must not exceed four minutes with not more than take-off power and without exceeding temperature limits established under E110 (See nomograph).

The established climb rate must be recorded in the Flight Manual.

B50 Minimum Sink Rate

The minimum achievable power off rate of descent (ft per minute) and the associated airspeed (knots) must be established by test at the maximum gross weight with the gyroplane trimmed at the minimum rate of descent airspeed. The minimum sink rate and required airspeed must be recorded in the Flight Manual.

B52 Best Glide Ratio

The best glide ratio is calculated by comparing the height lost (ft) to the maximum glide distance flown (ft). The power off rate of descent and the associated airspeed must be established by test at the maximum gross weight with the gyroplane trimmed to achieve maximum distance flown. The best glide ratio and required airspeed must be recorded in the Flight Manual.

Calculate as follows;

eg only;

(a) Sink rate to achieve maximum distance flown = 1250 ft/min.

(b) Speed to achieve maximum distance flown = 62 nm/hr = 62/60 nm/min = 1.03 x 6076 = 6258.28 ft/min.

(c) Best Glide ratio = (b)/(a) = 6258.28/1250 = 5.0:1

B55 Never Exceed Airspeed (VNE)

The maximum safe operating airspeed, considering the controllability, manoeuvrability, and requirements of B85 and B100 to B115, must be established. This airspeed must be established for the worst-case power condition between idle and full power.

The never-exceed speed, VNE, must not exceed 0.90 times the maximum speed demonstrated in flight tests (VDF)

The established VNE must be recorded in the Flight Manual.

B60 Minimum Controllable Speed for Level Flight (VMIN)

The minimum speed for level flight at maximum take-off power must be established.

The established VMIN must be recorded in the Flight Manual.

B65 Best Rate of Climb Airspeed (VY)

The airspeed at which the maximum rate of climb is achieved must be established.

The established VY must be recorded in the Flight Manual.

B70 Landing Distance

The distance required to land and come to rest from a point 50 ft above the landing surface, with zero wind, must be determined. An approach speed must be specified.

The landing distances and associated approach speeds must be recorded in the Flight Manual.

B75 Maximum Operating Altitude

The maximum safe operating altitude considering the controllability, manoeuvrability, and stability requirements B85 and B100 to B115, must be established up to an altitude selected by the applicant.

The maximum operating altitude must be recorded in the Flight Manual.

B80 Height/Velocity Envelope

The combinations of height and forward airspeed from which a safe landing cannot be made following engine failure must be established as a limiting height-speed envelope (graph).

The height-speed envelope graph must be recorded in the Flight Manual.

CONTROLLABILITY AND MANOEUVRABILITY**B85 General**

- (a) The gyroplane must be safely controllable and manoeuvrable with sufficient margin of control movement and blade freedom to correct for atmospheric turbulence and to permit control of the attitude of the gyroplane at all power settings at the critical weight and balance at sea-level and at the maximum selected altitude
- (i) During steady flight at speeds up to VDF;
 - (ii) During speed changes;
 - (iii) During changes of engine power, (including sudden loss of engine power); and
 - (iv) During any manoeuvre appropriate to the type, including: -
 - (1) Take-off;
 - (2) Climb;
 - (3) Turning Flight;
 - (4) Descent (power-on and -off), including vertical and spiral descents;
 - (5) Landing (power-on and -off); and
 - (6) Recovery to power-on flight from a baulked approach;
 - (7) During dynamic manoeuvres including steep turns, straight pull-outs, and roll-reversals.

The results of these tests must be recorded in the Flight Manual.

- (b) It must be possible to maintain any required flight condition and make a smooth transition from one flight condition to another (including turns and slips) without exceptional piloting skill, alertness or strength, and without danger of exceeding the limit manoeuvring load factor, under any operating condition probable for the type, with the engine operating at all possible associated power settings within the allowable range, including the effect of power changes and sudden engine failure. Normal variations in pilot techniques must not cause unsafe flight conditions.
- (c) Any unusual flying characteristics observed during the flight tests required to determine compliance with the flight requirements must be investigated.
- (d) A technique must be established, and demonstrated, for landing the gyroplane at maximum all up weight, with the engine at idle, without hazard to the occupants.
The procedure for landing at engine idle must be recorded in the Flight Manual.
- (e) The gyroplane shall not require unusual attention to prevent or stop any pitch oscillation at any and all power settings at the most critical weight and C of G combination at both sea level and at the maximum operating altitude
- (i) During steady flight at speeds up to VNE
 - (ii) During speed changes;
 - (iii) During changes of engine power, (including sudden loss of engine power); and
 - (iv) During any manoeuvre appropriate to the type, including: -
 - (1) Take off;
 - (2) Climb;
 - (3) Turning flight;
 - (4) Descent (power-on and -off);
 - (5) Landing (power-on and -off); and
 - (6) Recovery to power-on flight from a baulked approach;
 - (7) During dynamic manoeuvres including steep turns, straight pull-outs, and roll-reversals.

B90 Longitudinal Lateral and Directional Control

- (a) It must be possible at any speed including speeds below 1.3 VMIN and at any power settings including power off, to lower the rotor disc angle of attack so that a speed equal to 1.3 VMIN can be reached promptly.
- (b) It must be possible to raise the rotor disc angle of attack at VNE, at all permitted weight limitations and engine powers so that an airspeed of less than VNE can be reached promptly.
- (c) The control forces must not exceed those specified in C60 and C65
- (d) A maximum wind speed, maximum cross wind and maximum tail-wind must be established in which the gyroplane can be operated without loss of control near the ground in any manoeuvre appropriate to the type (such as cross wind take-offs and landings), with: -
 - (i) Critical weight; and
 - (ii) Critical centre of gravity.

These wind velocities must be specified in the Flight Manual.

B95 Pitch Control Force in Manoeuvres

The pitch control forces during turns or when recovering from manoeuvres must be such that at constant speed an increase in load factor is associated with an increase in control force.

STABILITY**B100 General**

- (a) The gyroplane must be able to be flown without undue piloting skill, alertness or strength in any normal manoeuvre for a period of time as long as that expected in normal operation.
- (b) There must be no tendency for the gyroplane to rapidly increase the turn rate, stick fixed, during a turn with normal accelerations of up to 1.5g at all allowable power settings.
- (c) The gyroplane shall not exhibit any serious tendency to enter a Pilot Induced Oscillation (PIO) at all power settings at the critical weight and centre of gravity, at sea-level and at the maximum altitude specified in B75 above.

B105 Longitudinal Stability

- (a) The longitudinal control must be such that, with constant engine power, an aft force and movement of the cyclic control is necessary to achieve an airspeed less than the trimmed airspeed.
- (b) The longitudinal control must be such that, with constant engine power, a forward force and movement of the cyclic control is necessary to achieve an airspeed greater than the trimmed airspeed.
- (c) The control force gradient must not reverse during any progressive application of control movement at airspeeds greater than VMIN and up to VNE.
- (d) Static longitudinal airspeed stability must be met at the following power and trimmed airspeed conditions: -
 - (i) Steady altitude at VY,
 - (ii) Full power at the lesser of VH or of VNE,
 - (iii) Engine idle at VY, and
 - (iv) Engine idle at 80 % VNE.
- (e) The pitch control forces during turns or load factor manoeuvres greater than 1.0 g must be such that an increase in load factor is associated with an increase in aft pilot control force, and a decrease in load factor is associated with a decrease in aft pilot control force.
- (f) Longitudinal manoeuvring stability must be met at the following power and trimmed airspeed conditions: -
 - (i) Steady altitude at VY,
 - (ii) Full power at the lesser of VH or of VNE,
 - (iii) Engine idle at VY, and
 - (iv) Engine idle at 80 % VNE.

- (g) With power set to maintain a constant altitude at airspeed VY, increasing the power to full power shall not result in a change in steady state trimmed airspeed of more than 10 % from VY.
- (h) With power set to maintain a constant altitude at airspeed VY, decreasing the power to idle shall not result in a change in a steady state trimmed airspeed of more than 10 % from VY
- (i) With power set to maintain a constant altitude at airspeed VY, decreasing the power to engine-off shall not result in a change in a steady state trimmed airspeed of more than 20 % from VY

B110 Lateral and Directional Stability

- a) Following an initial yaw disturbance, with the yaw controls fixed or free and other controls held fixed, the gyroplane should tend to correct automatically for disturbance in yaw within three cycles.
- b) The directional and lateral stability should be sufficient to prevent dangerous flight conditions following abrupt pedal displacements.
- c) Positive directional (yaw) static stability shall be demonstrated by the requirement for increasing rudder pedal force and displacement with increasing sideslip.
- d) No lateral or directional oscillations with periods less than 5 seconds shall be exhibited with primary cyclic controls fixed, and with primary cyclic controls free.
- e) Lateral and directional stability detailed in B110 (a) to (d) must be met at the following power and trimmed airspeed conditions: -
 - (i) In the climb, at maximum continuous power, at VY;
 - (ii) In level flight at: -
 - (1) The best climb speed VY, and
 - (2) Full power at the lesser of VH or of VNE,
 - (3) Engine idle at VY, and
 - (4) Engine idle at 80 % VNE.
 - (iii) At the minimum rate of descent speed (see B50), with and without the engine operating, and
 - (iv) At the recommended approach speed.

B115 Dynamic Longitudinal Stability

- (a) The gyroplane under smooth air conditions must exhibit no dangerous behaviour at any speed between VY and VNE with primary cyclic controls fixed, and with primary cyclic controls free.
- (b) No longitudinal oscillations with periods less than 5 seconds shall be exhibited with primary cyclic controls fixed, and with primary cyclic controls free.
- (c) Any excitable longitudinal oscillations with periods longer than 5 seconds do not diverge with primary cyclic controls fixed, and with primary cyclic controls free.

Dynamic Longitudinal stability detailed in B115 (a) to (c) must be met at the following power and trimmed airspeed conditions: -

- (i) Steady altitude at VY,
- (ii) Full power at the lesser of VH or of VNE,
- (iii) Engine idle at VY, and
Engine idle at 80 % VNE.

GROUND HANDLING CHARACTERISTICS**B120 Directional Stability and Control**

The gyroplane must have satisfactory ground handling characteristics, including freedom from uncontrolled tendencies in any condition expected in operation, particularly in all take-off conditions. Steering must be so arranged that pushing forward on the right pedal causes the gyroplane to steer to the right and pressing forward with the left pedal causes the gyroplane to steer to the left.

B125 Taxiing Condition

- (a) The gyroplane must be safely controllable and manoeuvrable when it is taxied over the roughest ground that may reasonably be expected in normal operation. The gyroplane should at least be suitable for operation from surfaces with short grass
- (b) The ground speeds up to which it is safe to taxi, take-off and touch down must be established. The established maximum ground speeds must be recorded in the Flight Manual.

B127 Ground Resonance

The gyroplane must have no dangerous tendency to oscillate on the ground with the rotor turning. This must be shown for all intended combinations of rotor speed and gyroplane forward speed, through spin up, take-off, landing and taxiing.

MISCELLANEOUS FLIGHT REQUIREMENTS**B130 Vibration**

Each part of the gyroplane must be free from excessive vibration under each appropriate combination of airspeed and engine power in all normal flight and ground operations.

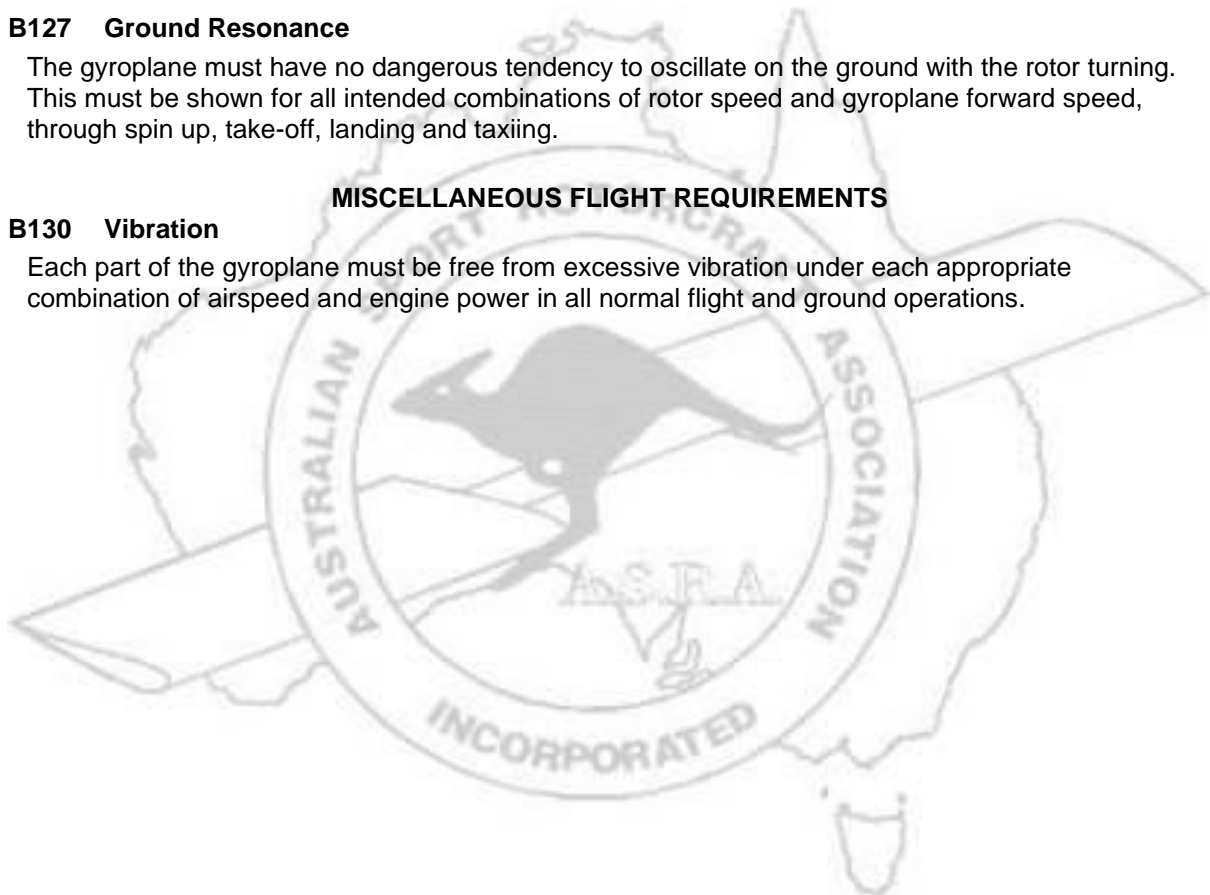

SUBPART C – Structure

General

C5 Loads

- (a) Strength requirements are stated as limit loads (the maximum load to be expected in service) and ultimate loads (limit loads multiplied by factors of safety). Unless told otherwise, loads stated are limit loads.
- (b) Unless stated otherwise, the inertia loads resulting from each major item of mass in the Gyroplane must balance with the flight and ground loads. (i.e. ground or flight disturbances should not cause unsafe conditions due to out of balance inertia loads).
- (c) If deflections under load would significantly change the distribution of external or internal loads, this redistribution must be considered.

C10 Factor of Safety

The strength of any safety critical part must have a safety factor of 1.5 for the application.

C15 Strength and Deformation

The structure and control systems must be able to support ultimate loads without permanent deformation. At any load up to limit loads, the deformation must not interfere with safe operation.

C20 Design Conditions

Compliance with the structural requirements of Subpart C must be shown by substantiated test or by a history of safe operations for all allowable combinations of: -

- (a) The design maximum weight;
- (b) Airspeeds up to VNE;
- (c) The balance limitations; and
- (d) The positive limit manoeuvring load factor.

FLIGHT LOADS

C25 General

- (a) Flight load factors represent the ratio of the aerodynamic force component (acting normal to the flight path of the gyroplane) to the weight of the gyroplane. A positive flight load factor is one in which the aerodynamic force acts upward, with respect to the gyroplane.
- (b) Compliance with the flight load requirements must be shown at each practicable combination of weight and disposable load.
- (c) Aerodynamic data required for the establishment of the loading conditions must be verified by tests, calculations or by conservative estimation.

C30 Limit Manoeuvring Load Factors

- (a) The gyroplane's rotor must be designed for positive limit manoeuvring load factor of 3.0 at all forward airspeeds from zero to the never exceed airspeed, VNE.
- (b) The rest of the gyroplane must be designed for positive and negative limit manoeuvring load factors of +3.0 and -0.5, respectively, at all forward speeds from zero to the never exceed airspeed, VNE

Compliance may be shown by use of acceptable aircraft manufacturing practices and by correct use of materials of known design strength and fatigue properties.

C35 Resulting Limit Manoeuvring Loads

The loads resulting from the application of limit manoeuvring load factors are assumed to act at the centre of the rotor hub and to act in directions so as to represent each critical manoeuvring condition.

C40 Yawing Conditions

The gyroplane must be designed for yawing loads on the vertical tail surface specified in C75.

C45 Engine Torque

- (a) The engine mount and its supporting structure must be designed for the effects of: -
- (i) The limit torque corresponding to the take-off power and propeller speed, acting simultaneously with 75% of the limit loads of C30, and
 - (ii) The limit torque corresponding to the maximum continuous power and propeller speed, acting simultaneously with the limit loads of C30.
 - (iii) Gyroscopic forces

Compliance may be shown with a "history of safe operations" from another mount that is similar in all significant respects.

- (b) For conventional reciprocating engines with a positive drive to the propeller, the limit torque to be accounted for in C45 (a) and C90 (d) is obtained by multiplying the engine mean torque by the propeller speed reduction factor and by one of the following factors: -
- (i) for four-stroke engines with five or more cylinders 1.33;
 - (ii) for four-stroke engines with one, two, three, or four cylinders, 8, 4, 3, or 2 respectively,
 - (iii) for two-stroke engines with three or more cylinders 2,
 - (iv) for two-stroke engines with one or two cylinders, 6 or 3 respectively.

C50 Side Load of Engine Mount

- (a) The engine mount and its supporting structure must be designed for a limit load factor in a lateral direction, for the side load of the engine mount, of not less than one third of the limit load factor of C30.
- (b) The side load prescribed in (a) may be assumed to be independent of other flight conditions.

CONTROL SURFACES AND SYSTEM LOADS**C55 Primary Control System**

The primary control system is constituted by: -

- (a) pitch and roll controls usually incorporated into a single control stick mounted approximately vertically with pivot points at the lower end or alternatively a Cessna-style yoke in tractor configurations; and
- (b) rudder pedals arranged so that depression of either pedal will deflect the rudder or rudders in the direction of the depressed pedal.

Overhead early Bensen style control sticks are not permitted.

C56 Control System Design

The primary control system and their attachment points must be designed to be withstand the loads set out below at C60 and also be capable of visual inspection during normal pre-flight checks and regular maintenance.

Pitch and roll control inputs will normally be transmitted to the rotor head by push-pull control rods although ASRA recognizes that some builders will opt to use push-pull control cables. A significant shortcoming with the use of push-pull cables is that the condition of the internal cable cannot be inspected, as is their reported less-precise "feel".

If a builder-to-order or a home-builder elects to use push-pull cables for pitch and roll in their project, the only approved push-pull cables are **Teleflex 60 Series** with 5/16" UNF thread ends or **Teleflex 80 Series** with 3/8" UNF thread ends. Such cables must be fitted strictly in accordance with the manufacturer's directions with particular care taken in relation to bend radii.

Push-Pull cable installations used for rudder control must be **Teleflex 40 Series** push-pull cables with 1/4" UNF thread ends.

Such Teleflex cable installations in build-to-order and home-builds have an operational life of **1000 hours**.

Because of the sealed or sheathed nature of push-pull cables, the visual inspection requirement is waived for: -

- (a) sheaths (if fitted) for rudder cable systems; and
- (b) push-pull cables running within sheaths fitted as original equipment by a recognized manufacturer; or
- (c) Teleflex push-pull cables running within sheaths in builds-to-order or home-builds as specified above.

C60 Limit Pilot Forces

The control system of a 2-seat Compliant Gyroplane must be designed and constructed to withstand a worse-case scenario of an instructor having to suddenly and forcefully overpower a student's crossed-up control inputs. For consistency, single seat compliant Gyroplanes are required to meet the same standard.

For primary controls the limit pilot forces are as follows: -

- (a) For rudder pedals - 580N or 130 pounds force;
- (b) For stick controls in pitch - 445N or 100 pounds force; and
- (c) For stick controls lateral inputs - 300N or 67 pounds force.

C70 Secondary Control Systems

Secondary control systems such as those for brakes, trim controls etc., must be designed for supporting the maximum forces that a pilot is likely to apply to those controls.

STABILISING AND CONTROL SURFACES

C75 Control Surface Loads

- (a) Each stabilising and control surface and its supporting structure, (other than the rotor blades), must be designed so that limit loads are not less than: -
 - (i) 720 N (160 lbs force) per square metre (evenly distributed over the control surface); or
 - (ii) The aerodynamic load resulting where the normal force coefficient C_N equals 1.5 at the maximum design speed.

Compliance with paragraph (a) of this section must be shown with realistic or conservative load distributions with allowance for any relative slipstream effects.

GROUND LOADS

C80 General

The limit ground loads specified in this Subpart are considered to be external loads and inertia forces that act upon a gyroplane structure.

In each specified landing condition, the external reactions must be placed in equilibrium by the linear and angular inertia forces in a rational or conservative manner

C85 Landing Gear - Shock Absorption

- (i) The landing gear shall be capable of absorbing the energy which would result from the Gyroplane being dropped at its maximum permitted take-off weight, in a normal landing attitude, from a height at which the main wheels are 300 mm (12 inches.) above the ground when in the normal position for landing and bearing no weight.
- (ii) In determining the ground loads on nose wheels the following conditions must be met, assuming that the shock absorbers and tyres are in their static positions: -
 - a) For aft acting loads the limit forces at the axle must be: -
 - 1) a vertical component of 2.25 times the static load on the wheel; and
 - 2) a drag component of 0.8 times the vertical load.
 - b) For forward acting loads the limit forces at the axle must be: -
 - 1) a vertical component of 2.25 times the static load on the wheel; and
 - 2) a forward component of 0.4 times the vertical load.
 - c) For sideways acting loads the limit forces at the axle must be: -
 - 1) a vertical component of 2.25 times the static load on the wheel; and
 - 2) a side component of 0.7 times the vertical load in either direction.

MAIN COMPONENT REQUIREMENTS**C90 Rotor Structure**

Each rotor assembly (including the rotor hub and blades) must be designed as prescribed in this section.

- (a) The rotor structure must be designed to withstand the critical flight loads prescribed in C30 and C35.
- (b) The rotor structure must be designed to withstand loads simulating, for the rotor blades and hub bar, the impact force of each blade against its teetering stops during ground operation.
- (c) The rotors and rotor head structure must be designed to withstand the maximum limit torque likely to be transmitted by any rotor spin-up device or rotor brake at all speeds from zero to maximum at which the device is designed to be engaged.

C95 Fuselage, Landing Gear and Rotor Pylon Structures

(a) Each fuselage, landing gear and mast structure must be designed as prescribed in this section. Resultant rotor forces may be represented as a single force applied at the rotor hub bar attachment point (teeter bolt).

- (b) Each structure must be designed to withstand: -
 - (i) The critical loads prescribed in C30 and C35;
 - (ii) The applicable ground loads prescribed in C80 and C85; and

The loads prescribed in C90 (c) and (d).

EMERGENCY LANDING CONDITIONS**C100 General**

- (a) The gyroplane, although it may be damaged in emergency landing conditions, must be designed as prescribed in this paragraph to protect each occupant under those conditions.
- (b) The gyroplane should be capable, in an emergency landing, to reduce its forward airspeed to near zero and subsequently contact the ground in a near vertical direction in a near level attitude, thereby minimizing load factors in the forward direction.
- (c) The structure must be designed to give each occupant every reasonable chance of escaping serious injury in an emergency landing incident, when proper use is made of belts and harnesses provided for in the design, in the following conditions: -
 - (i) Each occupant experiences ultimate inertial forces corresponding to the following load factors: -

Direction	Load Factor
Upward	4.5
Forward	9.0
Sideward	3.0
Downward	4.5

- (ii) These forces are independent of each other and are relative to the surrounding structure.
- (d) The supporting structure must be designed to restrain, under loads up to those specified in C100 (c) each item of mass that could injure an occupant if it came loose in a minor crash landing.
- (e) For a gyroplane with the engine located behind the occupant's (occupants') seat(s), the engine mounting structure must be able to restrain the engine, propeller and any other items supported by the engine mounting structure, when they experience an ultimate inertial force in the forward direction corresponding to a load factor of 15.
- (f) Fuel tanks, fuel lines, oil tanks and oil lines must be capable of retaining their contents under the inertial forces of C100 (c) without rupture.

OTHER- LOADS**C105 Loads from Single Masses**

The attachment means that all single masses, which are part of the equipment of the gyroplane, including ballast, must be designed to withstand loads corresponding to the maximum design load factors to be expected from the established flight and ground loads, including the emergency landing conditions of, C100.



SUBPART D - Design and Construction

D5 General

The strength of any part having an important bearing on safety and which is not easily analysed must be established by test.

D10 Materials

Where bolting is used, 'Aircraft' bolts must be used in the main frame and control components. (i.e. cheek and cluster plates and from the 'hands to the rotors'). Aircraft bolts must also be used on any part which has an important bearing on safety.

Materials shall be durable and suitable for the intended use, and design values (strength) must be chosen so that structural deficiency because of material variations is extremely remote as shown by test, analysis, service history, or manufacturer certification.

D15 Fabrication Methods

- (a) Workmanship of manufactured parts, assemblies, and aircraft shall be of high standard,
- (b) Methods of fabrication used must produce consistently sound structures,
- (c) Structures must be reliable with respect to maintaining the original strength under reasonable service conditions
- (d) Process specifications shall be followed where required.
- (e) Unconventional methods of fabrication must be substantiated by adequate tests or "history of safe operation"

D20 Locking of Connections

An acceptable means of locking must be provided on all connecting elements in the primary structure and in control and other mechanical systems which are essential to safe operation of the gyroplane.

In particular, self-locking nuts must not be used on any bolt subject to a rotational force in operation unless a positive locking device is used in place of or in addition to the self-locking device.

D25 Protection of Structure

Protection of the structure against weathering, corrosion, and abrasion, as well as suitable ventilation and drainage, shall be provided.

D30 Inspection

Means must be provided to allow inspection (including inspection of principal fixed and rotating structural elements and control systems), close examination, repair, and replacement of each part requiring periodic inspection, maintenance, adjustments for proper alignment and function, lubrication, or servicing.

D35 Provisions for Rigging and De-rigging

The design must be such that where any rigging and de-rigging may be expected to be carried out on a routine basis, the probability of damage or incorrect assembly is eliminated. It must be possible to inspect the gyroplane easily for correct assembly.

D40 Material Strength, Properties and Design Values

- (a) The design values must be chosen so that the probability of any structure being under strength because of material variations is extremely remote.
- (b) Materials must meet design strength values at ambient air temperatures between -5 and 54°C .

D45 Fatigue Strength

- (a) The detail design of the blade and hub bar of the gyroplane should be such that as far as reasonably practicable features that cause high stresses are avoided, especially if it cannot be shown that features of a similar design have accumulated considerable satisfactory service experience in a similar application.
- (b) The primary structures of the airframe or rotor shall be designed in consideration of the span-wise and chord-wise flexure cycles on the rotor at the worst combination of load, rotor speed and airspeed. All parts of the primary structure shall be easily accessible for inspection.

D50 Special Factors of Safety

The factor of safety prescribed in C10 must be increased to the special factors prescribed in this paragraph.

(a) Rotor Components Factor

The rotor head, rotor hub bar, and blade spar structure shall have a factor of safety of 2.0 for centripetal tension loads acting alone under the critical flight loads in accordance with C30 and C35.

- (b) The supporting structure and the attachment of rotor blade mass balance weights must have a factor of safety in excess of 1.5 when subjected to the combined loads resulting from:
 - (i) Accelerations of plus or minus 20g in the flap plane of the rotor,
 - (ii) Accelerations of plus or minus 20g in the lag plane of the rotor, and
 - (iii) The centripetal force at the maximum rotor speed.

Compliance may be shown by a history of safe operations.

D55 Casting Factors

For castings the strength of which is substantiated by at least one static test and which are inspected by visual methods, a casting factor of 2.0 must be applied. This factor may be reduced to 1.25 providing the reduction is substantiated by tests on not less than three sample castings and if these and all production castings are subjected to an approved visual and radiographic inspection or an accepted equivalent non-destructive inspection method.

D60 Bearing Factors

- (a) The factor of safety for bearing loads at bolted or pinned joints must be multiplied by a special factor of 2.0 to provide for:
 - (i) Relative motion in operation; and
 - (ii) Joints with clearance (free fit) subject to pounding and/or vibration, or both,
- (b) For control surface hinges and control system joints, compliance with the factors prescribed in D90 and D150 respectively.

D65 Fitting Factors

For each fitting (a part or terminal used to join one structural member to another), the following shall apply: -

- (a) For each fitting whose strength is not proven by limit and ultimate load tests in which actual stress conditions are simulated in the fitting and surrounding structures, a fitting factor of at least 1.8 must be applied to each part of:
 - (i) The fitting,
 - (ii) The means of attachment, and
 - (iii) The bearing on the joined members.
- (b) No fitting factor need be used for joint designs based on comprehensive test data (such as continuous joints in metal plating, welded joints, and scarf joints in wood).
- (c) For each integral fitting, the part must be treated as a fitting up to the point at which the section properties become typical of the member.

- (d) Local attachments in the load path between the safety belt or harness and the main gyroplane structure must be shown by analysis, test, or both, to be not less strong than the strength necessary for 3.0 times the loads corresponding to the emergency alighting inertia loads of C95.
- (e) When using only two hinges at each control surface, the safety factor for these hinges and the attached parts of the primary structure must be multiplied by a factor of 1.5.

D70 Cable Factor

An ultimate factor of safety of 2.0 on nominal cable strength must be applied to cables used for structural applications and for all primary control systems.

D75 Flutter Prevention and Structural Stiffness

Each major part of the gyroplane must be free from flutter and resonance, in both the free and fixed control mode at all airspeed and power conditions at speeds up to VNE.

CONTROL SURFACES AND ROTORS**D80 Drainage**

- (a) For each rotor blade: -
 - (i) There must be a means for venting the internal pressure of the blade,
 - (ii) Drainage holes must be provided for the blade, and
 - (iii) The blade must be designed to prevent water from becoming trapped in it
- (b) Sub-paragraphs (a)(i) and (ii) of this paragraph do not apply to sealed blades capable of withstanding the maximum pressure differentials expected in service.

D85 Control Surface Installations (other than rotor blades)

- (a) Movable control surfaces must be installed so that there is no interference between any surfaces or their bracings when one surface is held in any position and the others are operated through their full angular movement. This requirement must be met: -
 - (i) Under limit load conditions for all control surfaces through their full angular range; and
 - (ii) Under limit load on the gyroplane structure other than the control surfaces.
- (b) If a ground adjustable stabiliser is used, it must have stops that will limit its range of travel to that allowing safe flight and landing.

D90 Control Surface Hinges (other than rotor blades)

- (a) Control surface hinges, except ball, roller and spherical bearing hinges, must have a factor of safety of not less than 6.67 with respect to the ultimate bearing strength of the softest material used as a bearing.
- (b) For ball, roller or spherical bearing hinges, the approved rating of the bearing must not be exceeded.
- (c) Mechanical limits of rod-end spherical ball bearing hinges must not exceed the mechanical design limits of the joint in accordance with the requirements of D150

D95 Mass Balance

- (a) The spanwise balance of the rotor blades must be such that excessive out-of-balance vibration is prevented.
- (b) The chordwise balance of the blades must be such that the blades cannot be induced to flutter or weave in all flying conditions.
The chordwise balance of each blade in a pair must be the same.
The aerodynamic centre should be at or very close to the 25% chord.
- (c) The supporting structure and the attachment of rotor blade mass balance weights (if used) must have a factor of safety in excess of 1.5.

D100 Rotor Hub Tilt and Teeter Ranges

(a) Nomenclature

The rotor hub assembly of a gyroplane is an assembly that:

- (i) incorporates the rotor spindle axis, either as a fixed tube or fixed bolt (or both) or as a rotating spindle;
- (ii) is capable of being tilted from side to side and from vertical to the rear (as specified below);
- (iii) incorporates the component customarily called the torque tube or torque bar or variations thereof;
- (iv) may incorporate fixed components of a pre-rotation mechanism (if fitted); and
- (v) may incorporate a rotating bearing block to which side-towers with provision for rotor-teeter are laterally bolted.

The rotor assembly of a gyroplane comprises:

- (i) the rotor blades and blade straps; and
- (ii) a hub bar and elevated teeter block (if a solid hub-bar is used) OR (alternatively) Magni-style side-plates.

The following terminology must always be used:

- (i) **TILTING** is confined to describing the side-to-side and vertical-to-aft movement of a rotor hub and spindle assembly; and
- (ii) **TEETERING** is confined to describing the see-sawing movement of a rotor assembly within a rotor hub assembly.

(b) Hub Tilt Range

ASRA requires that:

- (i) the minimum rotor hub fore-and-aft hub tilt range for gyroplanes shall be **16 degrees**, with the forward limit (normally) being **vertical** and the rear limit (normally) being 16 degrees rear of vertical. Additional tilt range forward of vertical up to 4 degrees can be installed at the discretion of the designer to accommodate a stick forward rotor brake (if fitted). While no maximum rotor-hub fore-and-aft tilt limit is specified ASRA requires that the static clearances to other parts of the gyroplane specified elsewhere in these Standards be maintained.
- (ii) The minimum rotor hub side-to-side tilt range for gyroplanes shall be **16 degrees** (i.e. 8 degrees left tilt + 8 degrees right tilt. If the designer rigs a bias allowing one side to tilt slightly more than the other, the minimum tilt either side should still be 8 degrees).
- (iii) That the ranges stated above at (i) and (ii) are mandatory for gyroplanes constructed within Australia, either as builds-to-order, home-builds, hybrid conversions, or for the restoring or rebuilding of gyroplanes previously manufactured by companies that are no longer in business.
- (iv) In the case of gyroplanes manufactured as an identifiable and identical type by a company or companies that are still operating, where it is found that the tilt ranges of an inspected gyroplane are at variance in some respect from those specified above at (i) and (ii), the matter is to be referred to the Operations Manager. Unless otherwise approved by the Operations Manager, where there are existing minor non-compliance issues, the gyroplane must be able to demonstrate a history of safe operation and the non-compliant standards shall be clearly placarded in the cockpit to provide notice to the occupants.

NOTE: The ASRA Board at all times reserves the right to **deny** registration where the Board deems that there is a risk that the non-compliant feature may possibly give rise to a serious and imminent risk to flight safety.

- (c) Rotor Teeter Range
- (i) ASRA notes that UK scientific research has established that a rotor assembly in flight can easily teeter up to plus-or-minus **8 degrees** within the hub if control inputs are abrupt. Therefore, ASRA **strongly recommends** that measured static rotor teeter ranges be not less than plus or minus 8 degrees (ie, total range **16 degrees**).

WARNING

Extreme care must be exercised by operators who swap out rotor assemblies made by different manufacturers into their gyroplanes. If such swapping occurs it is essential that the existence of adequate static teeter range be checked and measured before flight is resumed.

NOTE: A constrained teeter range is implicated in one Australian fatality.

- (ii) That the range stated above at (i) is mandatory for gyroplanes constructed within Australia, either as builds-to-order, home-builds, hybrid conversions, or for the restoring or rebuilding of gyroplanes previously manufactured by companies that are no longer in business.
- (iii) In the case of gyroplanes manufactured as an identifiable and identical type by a company or companies that are still operating, where it is found that the teeter ranges of an inspected gyroplane are at variance in some respect from that specified above at (i), the matter is to be referred to the Operations Manager. Unless otherwise approved by the Operations Manager, where there are existing minor non-compliance issues, the gyroplane must be able to demonstrate a history of safe operation and the non-compliant standards shall be clearly placarded in the cockpit to provide notice to the occupants.

NOTE: The ASRA Board at all times reserves the right to **deny** registration where the Board deems that there is a risk that the non-compliant feature may possibly give rise to a serious and imminent risk to flight safety.

D101 Reserved

D102 Rotor Clearances

When a gyroplane rotor is generating lift sufficient for flight the long axis of each blade will generally "cone" upward at between 2 to 3 degrees. During ground operations, however, particularly at lower rpm, the blades will be much closer to horizontal or might even droop downward toward the tips due to weight of the blade. Rotor blades at low rpm are susceptible to being affected by wind gusts (known as "blade sailing") and will not respond quickly to control stick movements intended to counter the up or down movement of the gust affected blade. It is in these circumstances that an expensive rotor-to-tail strike is likely to occur.

With the rotor head assembly tilted aft until it rests on the aft tilt stop and with the rotor blade pulled down so that it rests on the teeter stop and is in line with a vertical propeller blade;

- (a) the clearance between the underside of the rotor blade and the tip of the vertical propeller blade shall be a minimum of 50 mm.
- (b) the rotor blade shall remain clear of the tail surfaces.
- (c) the minimum clearance from the top of pre-rotator is 12mm.

NOTE CAREFULLY - Different rotors have different degrees of rigidity and stiffness in the static state and each owner and/or operator must consider very carefully whether there is enough rotor-to-tail clearance to cope with a gust of wind further deflecting downward a slow-turning drooping rotor.

OWNER/OPERATORS ARE COMPLETELY ASSUMING THEIR OWN RISK FOR GROUNDHANDLING ROTOR TAIL STRIKE DAMAGE. IF THE OWNER/OPERATOR HAS CONCERNS THAT A TAIL STRIKE MIGHT OCCUR CAUSED BY A WIND GUST DEFLECTING A SLOWING DROOPING ROTOR THE MANUFACTURER OR IMPORTER IS TO BE CONSULTED. FOR HOMEBUILTS THE PRINCIPAL CONSTRUCTOR SHOULD

CONSIDER INCREASING THE HEIGHT OF THE MAST OR SHORTENING OR LOWERING THE VERTICAL TAIL SURFACES.**D103 Examination of First of Type Gyroplanes**

The ASRA Operations Manager or authorized delegate will be the only person permitted to sign-off first of type gyroplanes. The manufacturer will pay for ASRA expenses incurred in the inspection and subsequent signing off of the aircraft.

D105 Rotor Head Bearings

All rotor head bearings: -

- (a) Must have specifications that ensure that they have the strength and other properties assumed by the gyroplane designer, and
- (b) Must have their suitability established by experience or tests.

D107 Rotor Disc Loading

Recommended - 1.2-1.8 lbs/sq. foot. Rotor disc loading is a calculation of gross weight (in lbs) divided by the rotor disc area (square ft) of the gyro. Refer to the ASRA Technical Manual for a narrative.

CONTROL SYSTEMS**D110 General**

Each control must operate easily, smoothly and positively enough to allow proper performance of its functions.

For full travel of the control column the movement must be between 250 mm and 300 mm in the longitudinal plane (Fore and Aft) and between 200 mm to 250 mm lateral movement (roll).

D115 Stops

- (a) Each control system must have stops that positively limit the range of motion of the pilot's controls.
- (b) Each control system must have stops or other mechanical limitations to prevent positively possible interference with other control systems or moving components (that is, rudder stops to prevent interference with propeller).
- (c) Each stop must be located so that wear, slackness, or take-up adjustments will not adversely affect the control characteristics of the gyroplane because of a change in the range of travel of the control.
- (d) Each stop must be able to withstand any loads corresponding to the design conditions for that control.
- (e) Control column stops must be in the rotor head to avoid excessive control rod and control column loads.

D120 Rotor System Stops

Reserved

D125 Trim System

- (a) If a trim system is fitted which is operable in flight, proper precautions must be taken to prevent inadvertent, improper, or abrupt trim operation.
- (b) There must be means near the trim control to indicate to the pilot the direction of trim control movement relative to the gyroplane motion and a means to clearly indicate the position of the trim device with respect to the range of adjustment.
- (c) The trimmed range must be limited so that stick force cannot exceed 2.27 kg (5 lbs) on take-off or during level flight.

D130 Operation of Controls

When operating the controls from the cockpit, the control system, designed to the loads specified in C55, must be free from: -

- (a) Jamming;
- (b) Excessive friction; and
- (c) Excessive deformation under control load forces specified in C55

D135 Control System Details

- (a) Each detail of each control system must be designed and installed to prevent jamming, chafing and interference from baggage, passengers, loose objects, or the freezing of moisture.
- (b) There must be means in an enclosed or semi-enclosed cockpit to prevent the entry of foreign objects into places where they would jam the system.
- (c) There must be means to prevent the slapping of cables, tubes, or rods against other parts.
- (d) Each element of the flight control system must have design features, or must be distinctively and permanently marked, to minimise the possibility of incorrect assembly that could result in malfunctioning of the control system.
- (e) Where bell-cranks are used in any control system, they must be so designed that their range of travel is limited to a maximum of 45° each side of the mean position in respect to any movement measured at that bell-crank. The mean position is when the centre line between the bell-crank pivot and the bell-crank push/pull rod mount is at right angles to the push/pull rod.
- (f) Secondary controls must maintain any desired position without requiring constant attention by the pilot.
- (g) Friction devices fitted to throttles must be hand adjustable.
- (h) A guard must be provided to prevent rudder cables from entering the propeller arc.

D140 Spring Devices

The failure of any spring device used in the control system must not cause unsafe flight characteristics including: -

- (a) Abrupt attitude change that would result in loss of control, and
- (b) Possibility of failed spring device to interfere with other flight or propulsion systems.

D145 Cable Systems**WARNING**

Care must be taken to ensure that the swaging (crimping) tool is calibrated for the type of hardware upon which it will be used, be that metric or imperial. Failure to adhere to this caution may result in improperly swaged terminals that may result in in-flight failure.

- (a) Each cable, cable fitting, turnbuckle, splice, and pulley used must meet stated specifications. In addition: -
 - (i) No cable smaller than 3.0 mm (1/8 in.) diameter or, as the manufacturer specifies, may be used in primary control systems (ASRA preferred – 316 grade stainless steel);
 - (ii) 7 by 19 strand flexible control cable shall be used in primary control systems;
 - (iii) Each cable system must be designed so that there will be no hazardous change in cable tension throughout the range of travel under operating conditions and temperature variations; and
 - (iv) There must be means for visual inspection at each fairlead, pulley, terminal, and turnbuckle. This requirement precludes the use of heat shrink plastics to cover swaged terminals. Heat shrink plastic may be used on the ends of cables only to prevent fraying. It is further recommended that a suitable material be used on the cables either side of a swaged terminal in order to detect early movement of the cables through a swage. Nail polish has proven to be such a material.

- (b) Each kind and size of pulley must correspond to the cable with which it is used. Each pulley must have closely fitted guards to prevent the cables from being misplaced or fouled, even when slack. Each pulley must lie in the plane passing through the cable so that the cable does not rub against the pulley flange.
- (c) Fairleads must be installed so that they do not cause a change in cable direction of more than 3°, except where tests or experience indicate that a higher value would be satisfactory. The radius of curvature of fairleads must not be smaller than the radius of a pulley for the same cable.
- (d) Turnbuckles attached to parts having angular motion must be done so in a manner that will positively prevent binding throughout the range of travel.
- (e) Use of bridle cables clamped directly to rudder cables to affect nose or tail wheel steering is prohibited.

D150 Joints

- (a) Control system joints (in push-pull systems) that are subject to angular motion, except those in ball, roller and spherical bearing systems, must have a special factor of safety of not less than 3.33 with respect to the ultimate bearing strength of the softest material used as a bearing. This factor may be reduced to 2.0 for joints in cable control systems. For ball, roller or spherical bearings, the approved ratings must not be exceeded.
- (b) Rod end bearing spherical ball attachment (in push-pull systems): -
 - (i) Double Shear—The bolt through the spherical ball in rod end bearings (in push-pull systems) is preferred to be rigidly captured on both sides of the ball (double shear) so as not to put cantilever forces on the bolt.
 - (ii) Single Shear—Cantilevered bolt arrangement is permissible if bolt and the structure can be demonstrated to be appropriately robust to prevent flexure or fatigue, or both, of the structure or bolt, and the bolt is installed with its threaded portion inside the arm such that there is no significant bending on the threaded portion of the bolt.
- (c) The rod end bearing threads must use a locknut, or other locking means, to prevent the threaded joint from turning on its threads.
- (d) Special care shall be made that the spherical ball in the rod end bearings does not limit travel of the controls and that undue bending forces are not put on the rod end bearings.
- (e) Push-pull rods using rod end bearings on both ends should have freedom to twist at all extremes of the control inputs.

COCKPIT DESIGN

D155 General

The cockpit and its equipment must allow the pilot(s) to perform his or her duties without unreasonable concentration or fatigue.

D160 Cockpit View

Each cockpit must be designed so that: -

- (a) The pilots field of view is sufficiently extensive, clear and undistorted for safe operation; and
- (b) If a windscreen is provided, rain or mist must not unduly impair the pilots view along the flight path in normal flight and during landing. Vision may be provided by any canopy having a suitable opening.
- (c) The pilot is easily able to establish a pitch attitude by reference to a fixed point on the airframe (or a device attached to the airframe) that appears near the horizon in the pilot's view when looking forward.

D165 Windshields Windows and Doors

- (a) Windshields and windows if fitted must be constructed of a material that will not break into dangerous fragments or become opaque when damaged.
- (b) Doors, windows compartment covers, and inspection covers, if fitted, shall be designed so that, in the event of a malfunction of their latching mechanisms, they will not be forced open by the action of the slipstream.

D170 Cockpit Controls

- (a) Each cockpit control must be located to provide convenient operation, and to prevent confusion and inadvertent operation.
- (b) The controls must be located and arranged so that the pilot, or pilots, when properly secured by a safety harness, has full and unrestricted movement of all essential controls (Including allowance for bulky winter clothing.).
- (c) Secondary controls must maintain any desired position without requiring constant attention by the pilot(s), and must not tend to creep under loads or vibration. Controls must have adequate strength to withstand operating loads without failure or excessive deflection.

D175 Flight Controls

- (a) Cyclic forward for rotor tilt forward, backward for rotor tilt backward, right for right lateral roll, and left for left lateral roll.
- (b) Rudder-right foot pedal forward for nose-right yaw rotation, left foot pedal forward for nose-left yaw rotation.

D180 Seats

- (a) Each seat and its supporting structure must be designed for an occupant weight in accordance with B10(b) and for the maximum load factors corresponding to the specified flight and ground conditions including the emergency landing conditions prescribed in C100.
- (b) Seats, including cushions, must not deform under flight loads to such an extent that the pilot is unable to operate the controls safely or that the pilot is likely to operate the wrong controls.

D185 Safety Harnesses

- (a) The 4-point safety harness is required to be of a type that consists of 2 lap straps and 2 shoulder straps. Each strap is required to meet in a quick release central buckle.
- (b) The strength of the safety harness must not be less than that following from the ultimate loads for the flight and ground load conditions and for the emergency landing conditions according to C100 (b) considering the geometry of the harness and seat arrangement.
- (c) Shoulder harnesses must attach at a point on the airframe that would not be likely to depart the airframe forcibly upon a crash or result in ancillary occupant injury such as spinal compression.
- (d) Each safety harness must be attached so that the wearer is safely retained in the initial sitting position under flight and emergency landing accelerations.

See Figures 1, 2 and 3.

D190 Protection from Injury

Rigid structural members, or rigidly mounted items of equipment, must be padded where necessary to protect the occupant(s) from injury during minor crash conditions.

D195 Baggage Compartment

- (a) Each baggage compartment must be designed for its placarded maximum weight of contents and for the critical load distributions at the appropriate maximum load factors corresponding to the flight and ground load conditions of this Section.
- (b) Means must be provided to protect occupant(s) from injuries by movement of the contents of baggage compartments under the forward load factor specified in C100 (c).

D200 Emergency Exit

- (a) The cockpit must be so designed as to provide occupant/s with unimpeded and rapid escape in an emergency.
- (b) Where the cockpit is enclosed, the opening system must be designed for simple and easy operation. It must function rapidly and be designed so that it can be operated by each occupant strapped in his/her seat and also from outside the cockpit.

D205 Ventilation

When there is an enclosed cockpit it must be designed so as to afford suitable ventilation under normal flying conditions.



SUBPART E - Powerplant

GENERAL

E5 Installation

- (a) Powerplant installation includes the engine, propeller and each component that: -
 - (i) Is necessary for propulsion; or
 - (ii) Affects the safety of the propulsion unit between normal inspections and overhauls; or
 - (iii) Affects the control of the propulsion unit.
- (b) The powerplant must be constructed, arranged and installed to: -
 - (i) Ensure safe operation between normal inspection and overhaul; and
 - (ii) Be accessible for necessary inspections and maintenance.
- (c) Components of the powerplant, including fuel tanks and other parts of the gyroplane which are electrically conductive, must be earthed to the main frame
- (d) Where the occupants and engine are housed within an enclosed fuselage or where the occupants are within an enclosed fuselage, the occupants and engine must be separated by a sealed firewall
- (e) Where an engine is housed in a separate compartment, the fuel tank will not be located in that compartment unless the tank and all of its associated components are fireproof.

E10 Compatibility

- (a) The combination of engine and propeller must be compatible with the gyroplane, function in a satisfactory manner, and be operated safely within any limitations set under G10 and G20
- (b) Safe and satisfactory operation of the engine and propeller combination in the make and model gyroplane for a period of 40 hours flying without significant problems is acceptable evidence of compliance.
- (c) If significant changes are made to the engine, additional flying hours will be necessary to ensure that a complete period of 40 hours is achieved with the final standard of engine in combination with the propeller.

E15 Rotor Spin-up and Brake Systems

If a rotor spin-up or brake system is installed, it must be designed to prevent: -

- (i) It remaining engaged on take-off, and
- (ii) It becoming engaged in flight.

Limitations on the use of any rotor spin-up or brake systems must be specified in the Flight Manual.

E20 Flight Endurance Test

- (a) It shall be confirmed by flight tests that the proposed powerplant and rotor system operating limitations are compatible with the satisfactory functioning of the system over the proposed range of operating conditions and flight envelope.
- (b) A 40-hour flight endurance test shall be conducted on a gyroplane for which a Registration Certificate is sought.
 - (i) The gyroplane must not experience any significant problems or failures during the endurance test.
 - (ii) The endurance test must be conducted to a flight schedule which is representative of operational use.
 - (iii) Any problems or failures which occur must be resolved and extra flight testing conducted until 40 hours of trouble-free operation has accrued.
 - (iv) Development flying time may be counted towards the 40 hours of endurance testing, provided the Gyroplane is in the final configuration and the test flying was representative of operational use.
 - (v) The Operations Manager or Technical Manager may vary this hours requirement.

E25 Propeller Clearance

If an unshrouded propeller is installed, propeller clearances, at maximum weight, with the most adverse balance, with the propeller in the most adverse pitch position and taking account of likely airframe flexibility, must not be less than the following: -

- (a) Ground clearance. There must be a clearance of at least 180 mm between the propeller and the ground, with the landing gear statically deflected and, in the level, normal take-off or taxiing attitude, whichever is most critical. In addition, there must be positive clearance between the propeller and the ground in the level take-off attitude, with the most adverse combination of: -
 - (i) Undercarriage deflection; and
 - (ii) The corresponding tyre fully deflated.
- (b) There must be at least 25 mm radial clearance between the blade tips and other parts of the gyroplane airframe, plus any additional radial clearance necessary to prevent harmful vibration.
- (c) Clearance from occupant(s). There must be adequate clearance between the occupant(s) and the propeller so that it is not possible for the occupant(s), when seated and strapped in, to contact the propeller inadvertently. (This is not intended to cover the case where an occupant deliberately stretches and tried to touch the propeller).
- (d) It must be possible for either occupant to enter and leave the gyroplane on the ground without passing dangerously close to the propeller disc.

E27 Propeller Materials and Durability

The suitability and durability of materials used in the propeller must: -

- (a) Be established on the basis of experience or tests; and
- (b) Conform to specifications that ensure that they have the strength and other properties assumed in the design data.

Propeller design and construction must minimise the possibility of the occurrence of an unsafe condition of the propeller between overhauls.

FUEL SYSTEM**E30 General**

- (a) Each fuel system must be constructed and arranged to ensure a flow of fuel at a rate and pressure established for proper engine functioning under any normal operating condition.
- (b) Fuel feed systems may not supply fuel to the engine from more than one tank at a time, unless both tanks are interconnected in such a manner to ensure that all interconnected tanks feed to the last of the useable fuel (see E40).
- (c) The fuel system must be arranged to minimise the occurrence of vapour locks and to prevent introducing air into the system.

E35 Fuel Flow

- (a) Gravity systems - the fuel flow rate for each gravity system (main and reserve supply) must be at least 150% of the actual take-off fuel consumption of the engine.
- (b) Pump systems - the fuel flow rate for each pump system (main and reserve supply) must be at least 125% of the actual take-off fuel consumption of the engine at the maximum power established for take-off.

NOTE: - Fuel flow is measured after the float valve(s) in carburettor engines and at the inlet to the injectors in injected engines.

E40 Fuel Quantity

- (a) The useable fuel quantity for each tank must be established as not less than that quantity at which the first evidence of engine fuel starvation occurs under the most adverse fuel feed conditions occurring during take-off, climb, approach, and landing involving that tank.
- (b) The unusable fuel quantity must be established and identified on the fuel level indicator or indicating device

NOTE: - The unusable fuel quantity must be included in the gyroplane empty weight in B20 and specified in the Flight Manual.

E45 Integrity of Fuel Tanks

- (a) Each fuel tank must be able to withstand, without failure, inertia, fluid and structural loads that it may be subjected to in normal operation.
- (b) Where surging of fuel within the tank could cause significant changes in the centre of gravity of the gyroplane, means must be provided to reduce the surging to within acceptable limits.

E50 Fuel Tank Test

Each fuel tank must be able to withstand pressure of 1.5 psig (above atmospheric pressure) without failure or leakage.

E55 Fuel Tank Installation

- (a) Each fuel tank must be supported so that the loads resulting from the weight of the fuel are distributed to multiple support points on the airframe and on the fuel tank. In addition: -
 - (i) Provisions must be made to prevent chafing between each tank and its supports or any part of the frame or structure, and
 - (ii) Materials used for supporting the tank or padding the supporting members must be non-absorbent or treated to prevent the absorption of fuel.
- (b) Any compartment containing a fuel tank must be ventilated and drained to prevent accumulation of flammable fluids and vapours.
- (c) Structural damage which may result from a heavy landing in excess of the ultimate capability of the landing gear but within the emergency landing conditions of C100 must not result in rupture of the fuel tank, fuel filler pipe or fuel lines.
- (d) The fuel filler cap must not be rigidly fixed to an aircrew enclosure or to the gyroplane structure if it is possible, during a heavy landing as described in (c) above, for the fuel filler pipe to be ruptured or detached by deformation of the enclosure or movement of the tank with respect to the gyroplane structure.
- (e) The fuel outlet pipe must have sufficient excess length to significantly reduce the likelihood of the fuel outlet lines being ruptured or detached if the tank should move with respect to the surrounding structure during a heavy landing as described in (c) above.

E60 Fuel Tank Sump

- (a) Each fuel tank, if permanently installed, must have a drainable sump which is effective in all normal ground and flight attitudes and with a capacity of 0.10% of the tank capacity, or 120 ml, whichever is the greater. Alternatively: -
 - (i) A fuel system sediment bowl or chamber that is accessible for drainage and has a capacity of at least 25 ml must be fitted; and
 - (ii) Each fuel tank outlet must be located so that, in the normal ground attitude, water draining from any part of the tank will accumulate in the sediment bowl or chamber.
- (b) The drainage system must be readily accessible and easy to drain.
- (c) Each fuel system drain must have manual or automatic means for positive locking of the closed position.

E65 Fuel Tank Filler Connection

Fuel tank filler connections must be located outside the cockpit or must be located so that overflowed or spilled fuel runs overboard, and so that fuel or fuel vapours cannot enter any closed compartment of the gyroplane.

E70 Fuel Tank Vents

Each fuel tank must be vented from the top of the tank. In addition: -

- (a) Each vent outlet must be located and constructed in a manner that minimises the possibility of its being obstructed by ice or other foreign matter;
- (b) Each vent must be constructed to prevent siphoning of fuel during normal operation, nor should it create a partial vacuum;
- (c) Each vent must discharge clear of the gyroplane and clear of any electrical or exhaust components.

E75 Fuel Strainer or Filter

- (a) There must be a fuel filter between the fuel tank outlet and the fuel pump inlet (or carburettor inlet on gravity feed systems).

NOTE: - In some pressure fuel systems a filter between the tank and pump is not appropriate. Such installations will be considered on their merits.

- (b) Each filter or strainer must be easily accessible for replacement or drainage and cleaning.

E80 Fuel System Lines and Fittings

- (a) Each fuel line must be installed and supported to prevent excessive vibration and to withstand loads due to fuel pressure and accelerated flight conditions.
- (b) Each fuel line connected to components between which relative motion could exist must have provisions for flexibility.
- (c) Each flexible hose must be shown to be suitable for the particular application.
- (d) Fuel lines must be located so that leakage from any fuel line or connection must not impinge on hot surfaces or equipment which could cause a fire, nor fall directly onto any occupant.
- (e) Fuel lines must be located or insulated with respect to hot surfaces or equipment so as to minimize the risk of fire or vapour lock.

E85 Fuel Valves and Controls

- (a) The portion of fuel line between any fuel line stop valve and the carburettor must be as short as practically possible.
- (b) Each fuel line stop valve, if installed, must be at least fire resistant and must have either positive stops or effective detents in the ON and OFF positions.
- (c) Each fuel line stop valve, if installed, must be at least fire resistant and must have readily identifiable ON and OFF positions.

OIL SYSTEM**E90 General**

- (a) If an engine is provided with an oil system, it must be capable of supplying the engine with an appropriate quantity of oil at a temperature not exceeding the maximum established as safe for continuous operation.
- (b) Each oil system must have a useable capacity adequate for the endurance of the gyroplane.

E95 Oil Tanks

- a) Where an oil tank is fitted, it must be installed to: -
- (i) Meet the requirements of E55 (a), (b) and (d); and
 - (ii) Withstand any vibration, inertia and fluid loads expected in normal operation. Compliance with this requirement may be shown by satisfactory completion of the endurance test of E20.
- (b) The oil level must be easy to check without having to use any tools.
- (c) If the oil tank is installed in the engine compartment it must be made of fireproof material.

E100 Oil Tank Test

Each oil tank must be able to withstand a pressure of 5 psig (Above atmospheric pressure) without failure or leakage.

E105 Oil Lines and Fittings

- (a) Oil lines must comply with E80 and accommodate a flow of oil at a rate and pressure adequate for proper engine functioning under any normal operating conditions.
- (b) Oil lines must be so routed and if necessary supported so as to prevent chafing of any part of the engine or frame.
- (c) Breather lines must be arranged so that: -
 - (i) Condensed water vapour or oil that might freeze and obstruct the line cannot accumulate at any point;
 - (ii) The breather discharge will not constitute a fire hazard if foaming occurs or cause emitted oil to strike the occupant(s) or the pilot's windshields;
- (i) The breather does not discharge into the engine air induction system unless the engine is correctly fitted with a "positive crankcase ventilation" valve.

COOLING**E110 General**

- (a) The cooling provisions must be able to maintain the temperatures of powerplant components and engine fluids within acceptable temperature limits during all likely operating conditions.
- (b) Any coolant hoses must be so routed and if necessary supported as to prevent chafing on any part of the engine or frame.
- (c) Any coolant hoses that could burst and cause hot water or steam to strike the occupant(s) must be suitably lagged or shielded.

INDUCTION SYSTEM**E115 Air Induction**

The air induction system for the engine must supply the air required by the engine under all intended operating conditions. Compliance may be shown by satisfactory completion of the flight endurance test of E20.

EXHAUST SYSTEM**E120 General**

- (a) The exhaust system must ensure safe disposal of exhaust gases without fire hazard or carbon monoxide contamination in the cockpit.
- (b) Each exhaust system component must be separated from adjacent flammable parts of the gyroplane.
- (c) No exhaust gases may discharge dangerously near any oil or fuel system drain.
- (d) Each exhaust system component must be ventilated to prevent points of detrimental high temperature.

E125 Exhaust Manifold, Piping and Silencing

- (a) The exhaust system must be fireproof and must have means to prevent failure due to vibration and expansion by operating temperature.
- (b) The exhaust and silencing system must be supported to withstand the inertia loads to which it may be subjected in normal operation.
- (c) If the design of the exhaust system is such that after a failure in the exhaust system it can interfere with the propeller, additional restraint must be provided to ensure a degree of redundancy in the exhaust mounting.
- (d) Parts of the exhaust system connected to components between which relative motion could exist must have means for flexibility.

POWERPLANT CONTROLS AND ACCESSORIES**E130 General**

The portion of each powerplant control located in an engine compartment that is required to be operated in the event of fire must be at least fire-resistant.

E135 Engine Ignition System

- (a) A switch, readily accessible to the pilot, must be provided to enable each ignition circuit to be rendered inoperative.
- (b) The ignition switch(s) must be arranged and designed to prevent inadvertent operation.
- (c) Each battery ignition system must be supplemented by a charging system that is capable of sustaining normal flight engine operation should the battery fail.

E140 Propeller Speed

During take-off and climb at the recommended best rate-of-climb speed, the propeller must limit the engine rotational speed at full throttle to a value not greater than the maximum allowable rotational speed.

E145 Cowling and Nacelle

When an engine installation is cowled: -

- (a) Each cowling must be constructed and supported so that it can resist any vibration, inertia and air loads to which it may be subjected in operation.
- (b) There must be a means for rapid and complete drainage of each part of the cowling in the normal ground and flight attitudes. No drain may discharge where it will cause a fire hazard.
- (c) The cowling must be at least fire-resistant.
- (d) Each part behind an opening in the engine compartment cowling must be at least fire-resistant for a distance of at least 600 mm aft of the opening.
- (e) Each part of the cowling subjected to possible detrimental high temperatures because to its nearness to exhaust system ports or exhaust gas impinging on it must be fireproof and protected from detrimental heat damage.

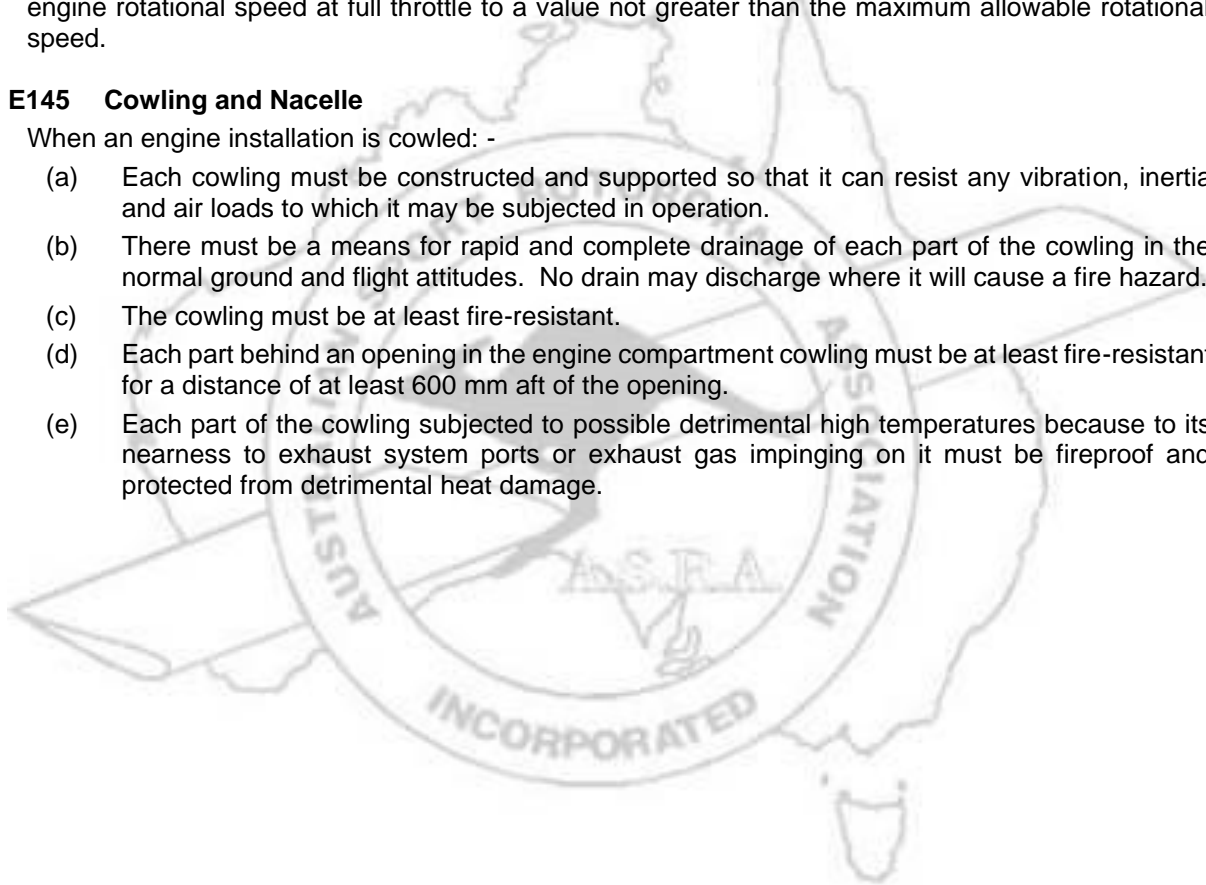

SUBPART F - Equipment

GENERAL

F5 Function and Installation

- (a) Each item of required equipment must: -
 - (i) Be of a kind and design appropriate to its intended function;
 - (ii) Be installed according to limitations specified for that equipment; and
 - (iii) Function properly when installed.
- (b) Instruments and other equipment must not in themselves, or by their effect upon the gyroplane, constitute a hazard to safe operation.

F10 Flight and Navigation Instruments

The following flight and navigational instruments are required to be fitted: -

- (a) An air speed indicator (calibrated in knots).
- (b) An altimeter (calibrated in feet).
- (c) A compass.
- (d) Yaw Indicator

F15 Powerplant Instruments

The following are the required powerplant instruments: -

- (a) Such pressure, temperature and rpm indicators as are necessary to operate the engine within its limitations;
- (b) A fuel quantity indicator for each fuel tank; and
- (c) An oil quantity indicator for each oil tank or engine sump, - for example, a dipstick.
- (d) A voltage indicator (For battery ignition systems.).

F20 Miscellaneous Equipment

Reserved

INSTRUMENTS – INSTALLATION

F25 Arrangement and Visibility

Flight and navigation instruments and powerplant instruments, required by F15, must be clearly arranged and plainly visible.

F30 Pitot and Static Pressure Systems

- (a) The design and installation of pitot and static pressure systems must be such that: -
 - (i) Positive drainage of moisture is provided;
 - (ii) Chafing of tubing, and excessive distortion or restriction at bends in the tubing, is avoided; and
 - (iii) The materials used are durable, suitable for the purpose intended, and protected against corrosion.

F35 Powerplant Instruments

- (a) Instruments and instrument lines.
 - (i) Each powerplant instrument line carrying flammable fluids under pressure must meet the requirements of E80.
 - (ii) Each line carrying flammable fluids under pressure must have restricting orifices or other safety devices at the source of pressure to prevent the escape of excessive fluid if the line fails.
- (b) Each exposed sight gauge used as a liquid quantity indicator must be protected against damage. The low-level indication range of the indicator must be plainly visible to the pilot.

ELECTRICAL SYSTEMS AND EQUIPMENT**F40 Battery Design and Installation**

Each battery must be installed so that: -

- (i) No explosive or toxic gases emitted by any battery in normal operation, or as the result of any probable malfunction in the charging system or battery installation, may accumulate in hazardous quantities within the gyroplane.
- (ii) No corrosive fluids or gases that may escape from the battery may damage surrounding structures or adjacent essential equipment.

F45 Electric Cables and Equipment

- (a) Each electric connecting cable must be of adequate capacity and correctly routed, attached and connected so as to minimise the probability of chafing, short circuits and fire hazards.
- (b) Overload protection of sufficient current carrying capacity must be provided for each electrical circuit.
- (c) Electric cables must not be attached to fuel, oil or fuel vent lines.

F50 External Lights

The installation and use of a flashing beacon/strobe is mandatory for operations at certified or registered aerodromes.

In the interests of safety, ASRA recommends that the flashing beacon/strobe be operating at all times during flight.

MISCELLANEOUS EQUIPMENT**F55 Airborne Radio and Radio Navigation Equipment**

Any fixed item of airborne radio equipment must comply with the following: -

- (a) The equipment and its antenna may neither in themselves, nor by their mode of operation or by their effect upon the operating characteristics of the gyroplane and its equipment, constitute a hazard to safe operation.
- (b) The equipment and its control and monitoring devices must be arranged so as to be easily controllable. Their installation must be such that they are sufficiently ventilated to prevent overheating.

SUBPART G - Operating Limitations and Information

G5 GENERAL

- (a) Each operating limitation specified in G20 and other limitations and information necessary for safe operation must be established.
- (b) The established limitations must be recorded in the Flight Manual
- (c) The operating limitations and other information necessary for safe operation must be made available to the pilot as prescribed in G30 to G55.

G10 Air-speed Limitations

All flight speeds must be stated in terms of indicated airspeed (IAS).

G15 Weight and Balance.

- (a) The maximum weight determined under B10 must be established as an operating limitation.
- (b) The balance limitations determined under B15 must be established as operating limitations.
- (c) The empty weight and the corresponding balance limitations must be determined in accordance with B20.

G20 Powerplant and Propeller Limitations

The powerplant and propeller limitations must be established on the basis of test or experience and these limitations must be recorded in the Flight Manual.

FLIGHT MANUAL

G25 Flight Manual or Pilot Operating Handbook

Each gyroplane must be provided with an ASRA approved Flight Manual applicable to that aircraft.

- (a) Content of the Flight Manual
 - B10 Load Distribution Limits (Hang Test)
 - B15 Maximum Weight
 - B20 Empty Weight
 - B32 Rotor Speed Limits
 - B40 Take-off Distance
 - B45 Climb Rate
 - B50 Minimum Sink Rate
 - B52 Best Glide Ratio
 - B55 Never Exceed Airspeed (VNE)
 - B60 Minimum Controllable Speed for Level Flight (VMIN)
 - B65 Best Rate of Climb Airspeed (VY)
 - B70 Landing Distance
 - B75 Maximum Operating Altitude
 - B80 Height/Velocity Envelope
 - B85 (a) Controllability and Manoeuvrability
 - B85 (d) Procedure for Landing at Engine Idle
 - B90 Operations in Windy Conditions
 - B125 Maximum Ground Speeds
 - E15 Rotor spin up limits
 - E40 Unusable Fuel Quantity
 - G5 Operating limitation
 - G20 Powerplant and Propeller Limitations

(b) Maintenance Program

The Flight Manual will contain the approved maintenance program for the gyroplane.

(c) Other Entries

Any other matter which will affect the safe operation of the particular gyroplane must also be entered into the Flight Manual.

MARKINGS AND PLACARDS

G30 General

(a) The gyroplane must be marked with: -

- (i) The markings and placards specified in G35 to G55; and
- (ii) Any additional information, instrument markings, and placards required for the safe operation of the gyroplane.

(b) Each marking and placard prescribed in sub-paragraph (a) of this paragraph: -

- (i) Must be displayed in a conspicuous place; and
- (ii) May not be easily erased, disfigured or obscured.

(c) The units of measurement used to indicate air speed on placards must be the same as those used on the air-speed indicator.

G35 Operating Limitations, Placards and Instrument Markings

Airspeed and power-plant limitations essential to the safe operation of the gyroplane must be plainly visible to the pilot. Where this cannot be achieved by instrument markings a placard must be provided. Where these limitations are shown by instrument markings each maximum and minimum safe operating limit must be marked by a red line.

G40 Compass

Unless the compass deviation is less than 5 degrees on all headings, the deviation values for magnetic headings (in not more than 45-degree increments) must be placarded near the compass.

G45 Fuel Quantity Indicator

Each fuel quantity indicator must be visible to the pilot in flight and be calibrated to read 'zero' during level flight when the quantity of fuel remaining in the tank is equal to the unusable quantity determined in accordance with E40.

G50 Control Markings

(a) Each cockpit control, other than primary flight controls, must be clearly marked as to its function and method of operation.

(b) Emergency controls must be coloured red.

(c) For powerplant fuel controls: -

- (i) The fuel tank selector control (if fitted) must be marked to indicate the position corresponding to each tank; and
- (ii) If safe operation requires the use of any tanks in a specific sequence, that sequence must be marked on or near the selector for those tanks.

G55 Miscellaneous Markings and Placards

- (a) Baggage compartment. Each baggage compartment must have placard stating the loading limitations.
- (b) Fuel filler opening must be marked at or near the filler cover with the minimum fuel grade and if applicable the fuel/oil ratio.
- (c) Fuel tanks - The useable fuel capacity of each tank must be marked either at the selector or the gauge or on the tank if this is translucent and visible to the pilot in flight.
- (d) Loading - If removable ballast is used, the place for carrying ballast must have a placard stating instructions for the proper placement and securing of the removable ballast under each loading condition for which each removable ballast is necessary.
- (e) Occupant warning - For a two-place gyroplane a placard showing an occupant warning must be plainly visible to both occupants when occupying the control seats, as follows: -

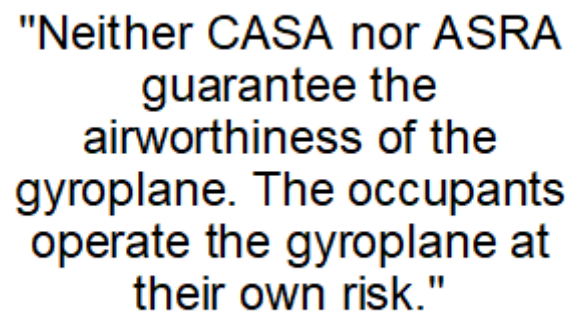

**"Neither CASA nor ASRA
guarantee the
airworthiness of the
gyroplane. The occupants
operate the gyroplane at
their own risk."**

INSTALLATION OF SHOULDER HARNESS

Figures 1, 2 and 3 below show the required installation geometry for this type of restraint.

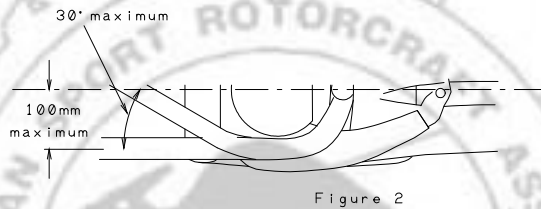
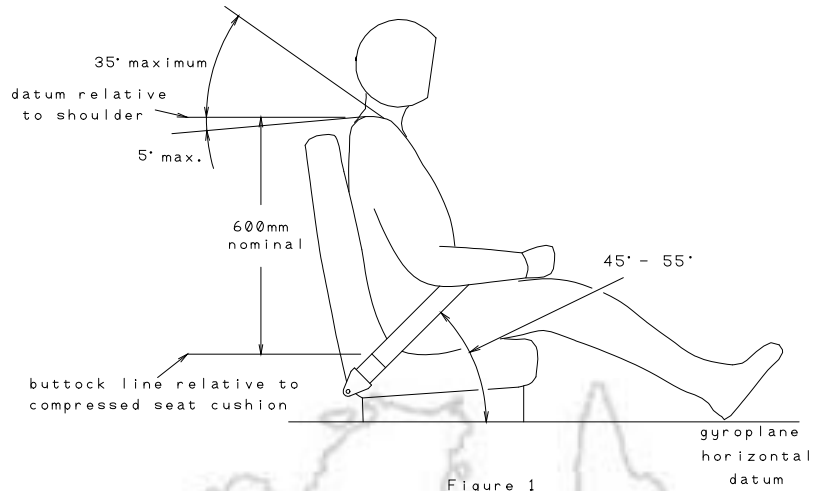

Range of Angles of Sholder Straps

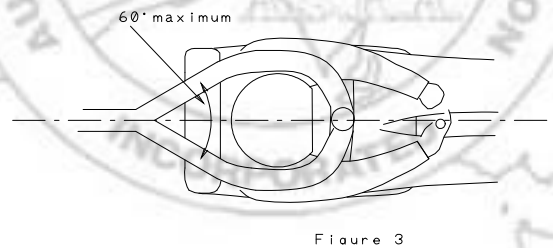

NOMOGRAPH OF EFFECTS OF TEMPERATURE AND ALTITUDE ON CLIMB RATES

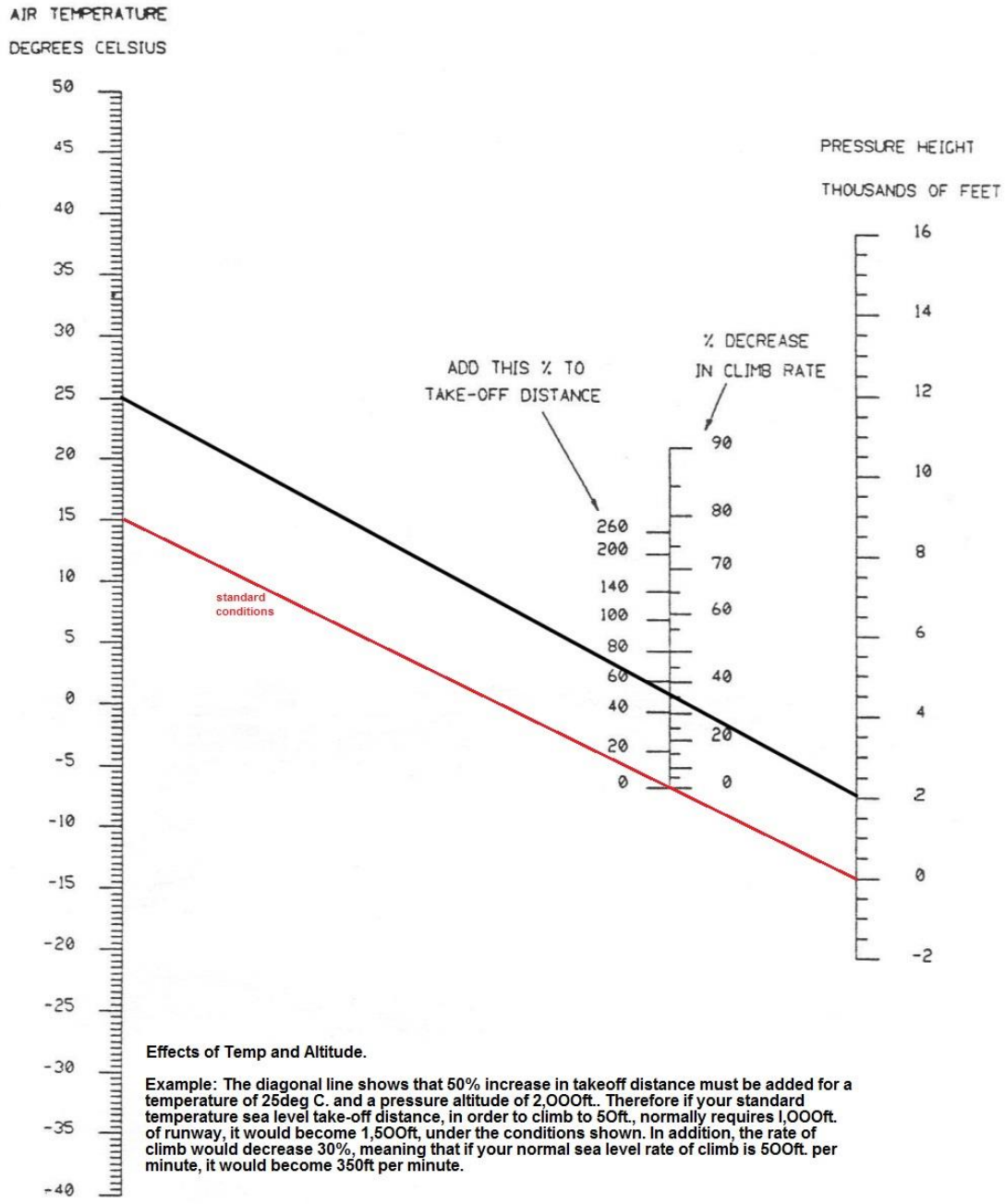

APPENDIX 1

The Approved ASRA Method – Hang Testing

Minimum 500 kg hoist required for 2 stroke single seaters.

Minimum 1000 kg hoist required for all other gyroplanes.

Step 1 – Decide on your reference surfaces

Firstly, while the gyro sits on its main-wheels and nose-wheel, decide whether there are any useful reference lines on the gyro itself when viewed from the side. For instance, if a gyro's keel is perfectly horizontal and the mast is tilted back 10 degrees, then these are perfect ready references that will really make it easy for you to judge hang angles. The front or rear edge of the mast is usually one of the best reference lines if the keel is not visible, horizontal or straight. Also, you need to bear in mind whether your gyro flies slightly nose-up or nose-down – studying in-flight photos can usually help you decide whether the keel is parallel with the horizon or not.

Step 2 – set up some flouro “brickies string line” as a vertical visual reference

This needs to be strung from the teeter bolt with a plumb-bob or similar on the bottom, long enough to reach to about wheel level. If tied to the end of the teeter bolt it may have to be draped over parts of the head, such as the pre-rotator ring gear (if fitted) or other parts of the frame. Make sure that it always hangs in line with the teeter bolt when viewed from where the camera has been set up.

Step 3 – Locking the torque tube

Next, the rotor head torque or bar tube is to be restrained at exactly the mid-point between the forward and rear pitch stops – this is most easily accomplished by cutting 1 or 2 hardwood wedges to suit and securely taping them in position (the test can be done satisfactorily with 1 wedge at the front only). Under no circumstances is the torque tube or bar to be locked by jamming the control stick in the mid-position – this will place too much strain on the control rods and links. (Members are reminded that the forward and rear limits of the control stick travel must always be as a result of the rotor head torque tube or bar touching the forward and rear stops at the rotor head, and NOT because the stick is contacting surfaces in the cockpit before the rotor head stops are touched).

Step 4 – Stick the reference scale on the mast and make your signs up

Next, create the reference scale (on the right) and stick it on the side of the mast. This scale is exactly 7 inches long and will be used as a reference when doing the final plotting on the resulting photographs of the hang and tilt-back test processes. Also, make up your A4 sized signs for “Full Fuel” or “No Fuel.”

Step 5 – Decide whether to rig up a string line to show your propeller thrust line or to do it later on computer

While you are fiddling with flouro brickies string line, this is the ideal time (if you want) to tie some carefully around your propeller hub and pull it forward tightly to the front of the gyro to represent your propeller thrust line. Make sure that the thrust-line string is exactly lined up with the centre of the propeller hub when viewed from the camera, and also make sure that the string is exactly perpendicular (90 degrees) to the propeller blades. This stringing must be done very, very carefully. The front of this string line will usually have to be tied to an aerial or temporary stick set up near the front.

Because of the likelihood that this string might interfere with the pod or the occupant, some people prefer not to bother with stringing the propeller thrust-line and opt to simply draw the line in on the photographs during the final plotting stage. It's really up to you.

Step 6 – Loading, Hoisting and Photographing

Next, place the required amount of fuel and occupant in the gyroplane and safely hoist off the ground.

The occupant in single-seaters is to be the customary pilot (usually the registered owner).

This test **MUST** be photographically recorded with a reasonable quality digital camera. The camera should set up level on a tripod far enough away from the gyro so that the entire machine is visible including the hanging point. The gyroplane **MUST** be swung so that the long axis or centreline of the gyro is exactly perpendicular (or 90 degrees) to the camera and the camera itself should be aimed directly at the brickies string line. Before taking the photo of the hang-test always double-check that the string line and teeter bolt are perfectly in line. Then, take 2 or 3 pictures.

The ASRA Recommended Hang Angles

With full tanks and occupant on board, the gyroplane should hang nose down at not more than 12 degrees. If the gyroplane hangs nose-down at a greater angle than this, then a new set of cheek plates might need to be made to move the head forward.

With empty tanks and occupant on board, the gyroplane should hang nose down not less than 9 degrees. If the gyroplane hangs nose-down at a lesser angle than this, then a new set of cheek plates might need to be made to move the head rearward.

Any moving of the rotor head forward or rearward needs to be done very carefully to ensure that the control rods remain well clear of other parts of the gyroplane structure after the shift, and that the original or usual relationship between control stick movement and torque tube or bar movement is preserved.

No Ballasting and Cheating Please

Ballasting of a gyroplane to bring it into forward and back hang-test recommended limits is **NOT AUTHORISED**. Added weight must **NEVER** be used to correct poor hang-balance, other than where a 2-seat side-by-side gyroplane cannot be flown solo other than with a pre-set amount of ballast (as in with the Purnong accident-gyro).

Also, ASRA full well knows that some members might be very tempted to pile in 4 or 5 bricks into the front of a pod, or tape a steel bar to the opposite side of the rear keel, to get a machine to hang properly for the photographic phase of the testing.

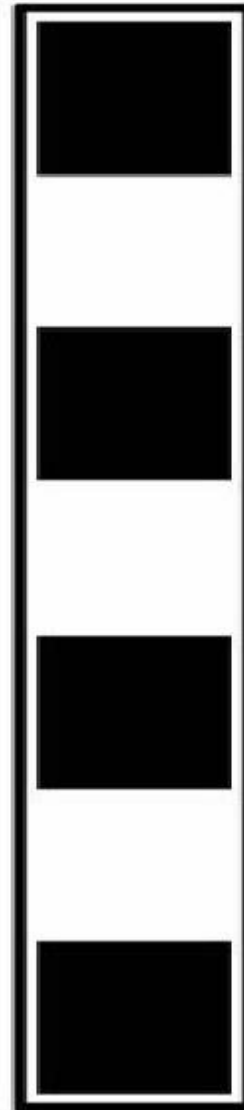

ASRA urges that members don't give in to any such temptation – the whole point of the exercise is to “get it right” – not to “fudge” the results.

If your gyro is not hanging within recommended limits

If your gyroplane hangs outside ONE or BOTH limits it might be a sign that you have a few problems! A Technical Advisor should be consulted.

ASRA suggests that if your gyroplane comes up outside these recommended limits when you initially hang test, then you should consult a TA and take your time to bring the gyroplane within limits and do repeat hang-testing before you ultimately submit your hang-test results. ASRA prefers that members “get it right” before formally submitting their photographic evidence.

The Approved ASRA Method – Tilt-Back (or Balance) Testing

This process is vital to provide a 2nd reference line on photographs to enable the vertical centre of gravity to be accurately plotted.

ASRA much prefers that the tilt-back test be done at the same site and same time as the hang testing, because the gyroplane can be safely raised and lowered using the same hoist used during the hang-testing. Furthermore, it is much safer to use a hoist because a slightly slackened rope can be kept around the rotor head to prevent the gyroplane overbalancing either forward or back during the tilt-back. The whole idea of the exercise is to get the gyroplane (with rotors ON) to teeter or balance on its main-wheels. The process needs to be done with at least a couple of people carefully holding, tilting and safely restraining the gyroplane as it tilts back toward the balance point.

Obviously, the main-wheels have to be quite high off the ground to allow the tail to tilt back and down. The usual height is about 18 inches or 50cm. The stands used for the main-wheels to sit on must be sufficiently strong, and the main-wheels must be securely chocked in position. Some people use car or truck ramps, although this is not the ASRA preferred method because of the risks and hazards associated with the gyroplanes rolling suddenly down off the ramps.

Step 1 – Remove the weighted string line from the teeter bolt and tie it to a long stick or similar

This time, the weighted flouro bricks string line is attached to a long stick or curtain rod. The string still needs to be about 8 feet long.

Step 2 – Loading, Hoisting, Positioning of Stands, and Lowering on to the Stands

Load the gyro as required. Then hoist the gyro up (ROTORS ON) high enough to enable the wheel stands to be positioned under the main-wheels. Position the stands and check for stability. The gyro is then gently lowered down on to the main-wheel stands, and the wheels are then chocked in position to prevent rolling.

Step 3 – Carefully Tilting Back the Gyro

ASRA suggests keeping the hoist sling around the rotor head for safety, with the line slackened off just enough to not pull on the mast and interfere with the balancing on the main-wheels.

With the assistance of helpers, the gyro is carefully tilted back until it reaches the point where it is balancing finely on the main-wheels.

Step 4 – Position the string line and take 2 or 3 pictures

A helper holding the long stick with the weighted flouro string line moves in and dangles the line as close to the centreline or long axis of the gyro as possible making sure that the line hangs precisely in line with and between the 2 main wheel axles. If the gyro had a large pod, the string should be held near the side of the pod and lined up between the 2 main wheel axles.

As before, the long axis of the gyro needs to be exactly perpendicular (90 degrees) to the camera. Obviously, because the gyro is now chocked and balancing precariously in position, this time the camera and tripod may need to be moved to line up properly. The camera should still be at the same distance from the gyro as the hang-test pictures were taken from, and – as before – the whole gyro must be visible in the photograph.

The camera operator should make a final check that the string line is precisely in line with and between the main-wheel axles, and in line with the camera. 2 or 3 pictures are then taken.

Ensuring that Your Tests are Correctly Recorded

You MUST properly record your testing process using a good digital camera.

When taking the required digital photographs, don't forget to include the reference scale on the mast as well as A4 signs showing "Full Tank" or "Empty Tank."

Plotting on the Resulting Photographs – Vertical Centre of Gravity

You now should have 2 sets of photographs - the hang test photos and the tilt-back or balance test photos. (Make sure you don't mix up full tank with empty tank pictures.

Print a few copies of each out. To quickly find out where your vertical centre of gravity is, cut out a small vertical rectangular piece of one of your tilt-back pictures showing the flouro string line in the middle of the long axis of the rectangle and make sure there is some of the gyro structure also visible behind the string line.

Carefully position the cut out rectangle over one of your hang test pictures and line the rectangle up so that the gyro structure showing in the rectangle blends together or matches up into the structure showing on the hang test picture. Fix or glue it in that position.

You can now draw the lines to match up as an X like shown in the diagram shown before. Congratulations! You have now plotted the vertical centre of gravity!

This process can also easily be done using a photo-editing program on a computer. In fact, the photo-editing method is the method preferred by ASRA because those images can be stored and transmitted by email.

Plotting on the Resulting Photographs – Propeller Thrust Line

If you rigged up a flouro brickies string line to show the propeller thrust line, then it's already there! If you didn't, now is the time for you to carefully and precisely draw a line on your photograph representing where the propeller thrust line is. It must be perfectly drawn to be in line with the propeller rotational axis and exactly perpendicular (90 degrees) to the propeller blades. Draw the line long enough so that it crosses both the hang-test and the tilt-back string lines shown on the photograph.

Final Plot – Measuring the Distance Between the vertical C of G and the Thrust Line

This is where you use a magnifying glass to spot the reference scale on the side of your gyro's mast in the picture and then carefully use it to measure the distance between the vertical centre of gravity and the propeller thrust line. The reference scale is made up of alternating black and white 1 inch blocks

and is 7 inches long. Use the scale to accurately measure the distance between your lines on the photograph. One inch equals 25.4mm.

Plotting for Possible Centre of Gravity "Migration"

ASRA is very keen to determine whether vertical centre of gravity "migration" from fuel burn-off in all gyros is a cause for concern or not.

Therefore, for single seaters you are required to plot the vertical centre of gravity for these 2 conditions:

- a) EMPTY FUEL TANK
- b) FULL FUEL TANK

ASRA considers this research as vital and urges that everyone undertakes these required tasks positively and carefully.

At the Finish

You will now know whether your gyroplane is Low Thrust Line (LTL); Centre Line Thrust (CLT); or, High Thrust Line (HTL) for particular fuel combinations.

And, importantly, you will be able to objectively verify your conclusions by providing your pictures as evidence.

WHAT YOU WILL ULTIMATELY HAVE TO SUBMIT TO ASRA

What precisely needs to be recorded for ASRA.

The following is a table of what results need to be photographically recorded, kept intact by you and submitted as part of the new registration process:

For single seat gyroplanes

(EMPTY FUEL TANK)

Hang Test: Empty Fuel Tank

1 an A4 sized paper print of a digital side-on photograph of the gyroplane with empty fuel tank and occupant undergoing hang test with a vertical line visible on the photograph from teeter bolt hang point;

Tilt-back Test: Rotors On with Empty Fuel Tank

2 an A4 sized paper print of a digital side-on photograph of the gyroplane with empty fuel tank and occupant undergoing tilt-back test with a vertical line visible on the photograph from a point on the frame precisely between the main wheels;

(FULL FUEL TANK)

Hang Test: Full Fuel Tank

3 an A4 sized paper print of a digital side-on photograph of the gyroplane with full fuel tank and occupant undergoing hang test with a vertical line visible on the photograph from the teeter bolt hang point;

Tilt-back Test: Rotors On with Full Fuel Tank

4 an A4 sized paper print of a digital side-on photograph of the gyroplane with full fuel tank and occupant undergoing tilt-back test with a vertical line visible on the photograph from a point on the frame precisely between the main wheels;

Two Resulting Vertical C of G Plots

5 you will also be required to provide 2 A4 size images of the resulting vertical centre of gravity plots with the intersecting hang-test and tilt-back lines clearly visible with the intersection of those two lines visible as a shallow X.

Notes

6 an A4 size sign or placard shall be visible in each hang and tilt-back digital photograph indicating "full tank" or "empty tank".

7 a vertical measuring reference strip made of printed paper 1 inch wide and 7 inches high must be stuck to the mast and visible in all the digital photographs.

8 rotor head torque tube to be locked at pitch-range mid-point for hang-testing by secure chocking at the head (locking at control stick end is absolutely prohibited);

9 hang testing is obviously done with the rotors off, and the teeter bolt MUST be supported within a hang-test hoisting block that many people already have – under no circumstances can a gyroplane be lifted or hoisted on an unsupported teeter bolt alone.

10 the usual "on wheels" registration picture is also to be submitted; and

11 an accurate statement of the current empty weight of the gyroplane in kilograms is also to be submitted.

Getting Assistance

For specific inquiries please firstly consult a TA in your local area, or email or telephone the President, The Operations Manager or the Technical Manager via the ASRA website links.

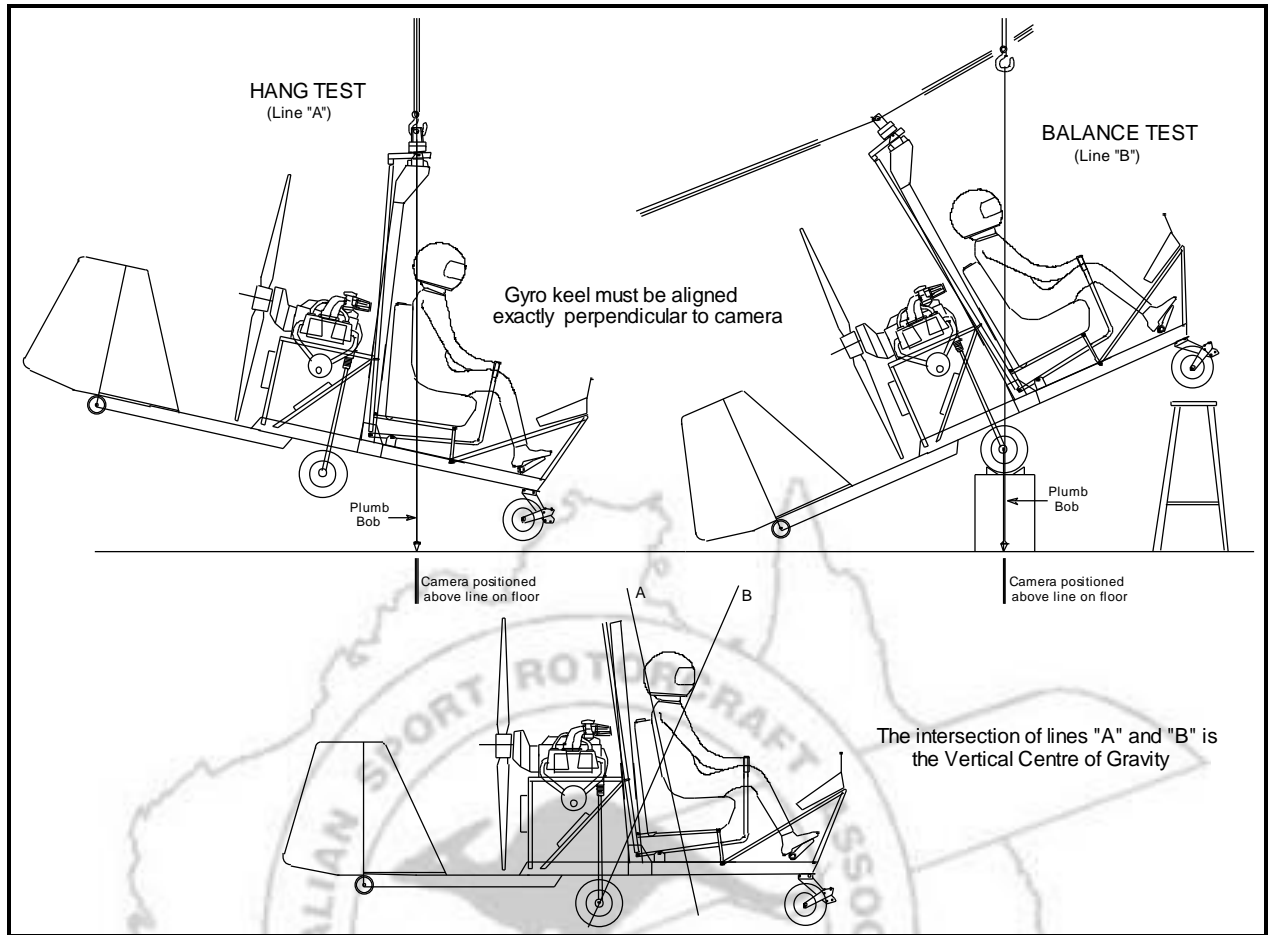

Diagram drawn and supplied by Tim McClure